

PowerFlex 527 Adjustable Frequency AC Drive

Catalog Number 25C



Original Instructions

Important User Information

Solid-state equipment has operational characteristics differing from those of electromechanical equipment. Safety Guidelines for the Application, Installation and Maintenance of Solid State Controls (publication [SGI-1.1](#) available from your local Rockwell Automation® sales office or online at <http://www.rockwellautomation.com/literature/>) describes some important differences between solid-state equipment and hard-wired electromechanical devices. Because of this difference, and also because of the wide variety of uses for solid-state equipment, all persons responsible for applying this equipment must satisfy themselves that each intended application of this equipment is acceptable.

In no event will Rockwell Automation, Inc. be responsible or liable for indirect or consequential damages resulting from the use or application of this equipment.

The examples and diagrams in this manual are included solely for illustrative purposes. Because of the many variables and requirements associated with any particular installation, Rockwell Automation, Inc. cannot assume responsibility or liability for actual use based on the examples and diagrams.

No patent liability is assumed by Rockwell Automation, Inc. with respect to use of information, circuits, equipment, or software described in this manual.

Reproduction of the contents of this manual, in whole or in part, without written permission of Rockwell Automation, Inc., is prohibited.

Throughout this manual, when necessary, we use notes to make you aware of safety considerations.



WARNING: Identifies information about practices or circumstances that can cause an explosion in a hazardous environment, which may lead to personal injury or death, property damage, or economic loss.



ATTENTION: Identifies information about practices or circumstances that can lead to personal injury or death, property damage, or economic loss. Attentions help you identify a hazard, avoid a hazard, and recognize the consequence.



SHOCK HAZARD: Labels may be on or inside the equipment, for example, a drive or motor, to alert people that dangerous voltage may be present.



BURN HAZARD: Labels may be on or inside the equipment, for example, a drive or motor, to alert people that surfaces may reach dangerous temperatures.



ARC FLASH HAZARD: Labels may be on or inside the equipment, for example, a motor control center, to alert people to potential Arc Flash. Arc Flash will cause severe injury or death. Wear proper Personal Protective Equipment (PPE). Follow ALL Regulatory requirements for safe work practices and for Personal Protective Equipment (PPE).

IMPORTANT

Identifies information that is critical for successful application and understanding of the product.

	Important User Information	2
	Preface	
Overview	Who Should Use this Manual	7
	Additional Resources	7
	Manual Conventions	8
	Drive Frame Sizes	8
	Product Environmental Information.	8
	General Precautions	9
	Catalog Number Explanation	10
	Chapter 1	
Installation/Wiring	Mounting Considerations.	11
	AC Supply Source Considerations	15
	General Grounding Requirements	16
	Fuses and Circuit Breakers	18
	Power and Control Module	23
	Control Module Cover	26
	Power Module Terminal Guard	26
	Power Wiring.	27
	Power Terminal Block.	30
	I/O Wiring.	30
	Control I/O Terminal Block.	32
	CE Conformity	34
	Chapter 2	
Start Up	Prepare for Drive Start-Up.	41
	Understanding the PowerFlex 527 Display and Indicators	42
	Drive Programming Tools	47
	Language Support	47
	Using the Ethernet Port	48
	Chapter 3	
Configuring the PowerFlex 527 Drive with Integrated Motion	Configure the Drive	49
	Configure the Logix Designer Application Project	50
	Add a PowerFlex 527 Drive	55
	Configure the PowerFlex 527 Drive.	57
	Apply Power to the PowerFlex 527 Drive	80
	Test and Tune the Axes – Velocity and Position Control Modes	81

	Chapter 4	
PowerFlex 527 Integrated Safe Torque-Off	Certification	85
	Description of Operation	86
	Probability of Dangerous Failure Per Hour (PFH)	87
	Safe Torque-Off (STO) Feature	87
	Out-of-Box (OOB) Safety State	89
	Safe Torque-Off Status	91
	Explicit Messages	92
	Chapter 5	
Hardwired Control of Safe Torque-Off	Description of Operation	95
	Safe Torque-Off Connector Data	98
	Wire the Safe Torque-Off Circuit	98
	Safe Torque-Off Specifications	99
	Chapter 6	
Network Control of Safe Torque-Off	Understanding Integrated Safety Drive Replacement	105
	Replacing an Integrated Safety Drive in a GuardLogix System	105
	Motion Direct Commands in Motion Control Systems	112
	Functional Safety Considerations	118
	Chapter 7	
Troubleshooting	Safety Precautions	119
	Interpret Status Indicators	119
	General Troubleshooting	126
	Logix5000 Controller and Drive Behavior	127
	Appendix A	
Supplemental Drive Information	Certifications	131
	Environmental Specifications	132
	Technical Specifications	133
	Power Specifications	136
	Appendix B	
Accessories and Dimensions	Product Selection	139
	Product Dimensions	147
	Appendix C	
Out-of-Box Configuration	Recommended Out-of-Box Settings	161
	Setting the ACO/AVO Attribute	164

Encoder Option Card Usage	Appendix D	
	Installing the Encoder Option Card	165
	Removing the Encoder Option Card.....	166
	Encoder Option Card Usage	166
	Wiring Notes	168

Index

Notes:

Overview

The purpose of this manual is to provide you with the basic information needed to install, start-up and troubleshoot the PowerFlex® 527 Adjustable Frequency AC Drive.

For information on...	See page...
Who Should Use this Manual	7
Additional Resources	7
Manual Conventions	8
Drive Frame Sizes	8
General Precautions	9
Catalog Number Explanation	10

Who Should Use this Manual

This manual is intended for qualified personnel. You must be able to program and operate Adjustable Frequency AC Drive devices. In addition, you must have a working knowledge and understanding of Control Logix/Studio 5000 and CIP Motion.

If you do not have a basic understanding of the PowerFlex 527 drives, contact your local Rockwell Automation sales representative for information on available training courses.

Additional Resources

These documents contain additional information concerning related products from Rockwell Automation.

Title	Publication
GuardLogix 5570 Controllers User Manual	1756-UM022
GuardLogix 5570 Controller Systems Safety Reference Manual	1756-RM099
CompactLogix 5370 Controllers User Manual	1769-UM021
Wiring and Grounding Guidelines for Pulse Width Modulated (PWM) AC Drives	DRIVES-IN001
Preventive Maintenance of Industrial Control and Drive System Equipment	DRIVES-TD001
Integrated Motion on the EtherNet/IP Network Configuration and Startup User Manual	MOTION-UM003
Integrated Motion on the EtherNet/IP Network	MOTION-RM003
PowerFlex DB (Dynamic Braking) Resistor Calculator	PFLEX-AT001
Safety Guidelines for the Application, Installation and Maintenance of Solid State Control	SGI-1.1
Guarding Against Electrostatic Damage	8000-4.5.2

You can view or download publications at <http://www.rockwellautomation.com/literature>. To order paper copies of technical documentation, contact your local Allen-Bradley distributor or Rockwell Automation sales representative.

Manual Conventions

- In this manual we refer to PowerFlex 527 Adjustable Frequency AC Drive as: drive, PowerFlex 527, PowerFlex 527 drive or PowerFlex 527 AC drive.
- Specific drives within the PowerFlex 520-series may be referred to as:
 - PowerFlex 523, PowerFlex 523 drive or PowerFlex 523 AC drive.
 - PowerFlex 525, PowerFlex 525 drive or PowerFlex 525 AC drive.
 - PowerFlex 527, PowerFlex 527 drive or PowerFlex 527 AC drive
- The following words are used throughout the manual to describe an action:

Words	Meaning
Can	Possible, able to do something
Cannot	Not possible, not able to do something
May	Permitted, allowed
Must	Unavoidable, you must do this
Shall	Required and necessary
Should	Recommended
Should Not	Not Recommended

- The Studio 5000 Automation Engineering and Design Environment™ (formerly RSLogix 5000) combines engineering and design elements into one standard framework that enables optimized productivity and reduced time to commission. As part of the Studio 5000 environment, Logix Designer™ is the tool used to program Logix programmable automation controllers for process, batch, discrete, drives, safety and motion-based systems. The Studio 5000 environment is the foundation for system engineering design tools and capabilities — it is the one tool for engineers to design and develop all the elements of their control system.

These conventions are used throughout this manual:

- Bulleted lists such as this one provide information, not procedural steps.
- Numbered lists provide sequential steps or hierarchical information.

Drive Frame Sizes

The PowerFlex 527 AC drive belongs to the new generation of PowerFlex 520-series drives which also consist of PowerFlex 523 and PowerFlex 525 drives.

Similar PowerFlex 520-series drive sizes are grouped into frame sizes to simplify spare parts ordering, dimensioning, etc. A cross reference of drive catalog numbers and their respective frame sizes is provided in [Appendix B](#).

Product Environmental Information

Rockwell Automation maintains current product environmental information on its website at

<http://www.rockwellautomation.com/rockwellautomation/about-us/sustainability-ethics/product-environmentalcompliance.page>

General Precautions



ATTENTION: The drive contains high voltage capacitors which take time to discharge after removal of mains supply. Before working on drive, ensure isolation of mains supply from line inputs [R, S, T (L1, L2, L3)]. Wait three minutes for capacitors to discharge to safe voltage levels (DC Bus voltage is less than 50V DC). Failure to do so may result in personal injury or death. Darkened display LEDs is not an indication that capacitors have discharged to safe voltage levels.

ATTENTION: Only qualified personnel familiar with adjustable frequency AC drives and associated machinery should plan or implement the installation, start-up and subsequent maintenance of the system. Failure to comply may result in personal injury and/or equipment damage.

ATTENTION: This drive contains ESD (Electrostatic Discharge) sensitive parts and assemblies. Static control precautions are required when installing, testing, servicing or repairing this assembly. Component damage may result if ESD control procedures are not followed. If you are not familiar with static control procedures, reference A-B publication [8000-4.5.2](#), "Guarding Against Electrostatic Damage" or any other applicable ESD protection handbook.

ATTENTION: An incorrectly applied or installed drive can result in component damage or a reduction in product life. Wiring or application errors, such as undersizing the motor, incorrect or inadequate AC supply, or excessive ambient temperatures may result in malfunction of the system.

ATTENTION: The bus regulator function is extremely useful for preventing nuisance overvoltage faults resulting from aggressive decelerations, overhauling loads, and eccentric loads. However, it can also cause either of the following two conditions to occur.

1. Fast positive changes in input voltage or imbalanced input voltages can cause uncommanded positive speed changes.
2. Actual deceleration times can be longer than commanded deceleration times. However, a "Decel Override" fault is generated if the drive remains in this state for one minute. If this condition is unacceptable, the bus regulator must be disabled by setting the Bus Regulator Action in Logix Designer. In addition, installing a properly sized dynamic brake resistor will provide equal or better performance in most cases. See [Dynamic Brake Resistors on page 140](#) to select an appropriate resistor for your drive rating.

ATTENTION: Risk of injury or equipment damage exists. Drive does not contain user-serviceable components. Do not disassemble drive chassis.

Catalog Number Explanation

1-3	4	5	6-8	9	10	11	12	13	14
25C	–	B	2P3	N	1	1	4	–	–
Drive	Dash	Voltage Rating	Rating	Enclosure	Reserved	Emission Class	Reserved	Dash	Dash

Code	Type
25C	PowerFlex 527

Code	EMC Filter
0	No Filter
1	Filter

Code	Braking
4	Standard

Code	Voltage	Phase
V	120V AC	1
A	240V AC	1
B	240V AC	3
D	480V AC	3
E	600V AC	3

Code	Interface Module
1	Standard

Code	Enclosure
N	IP20 NEMA / Open

Output Current @ 1 Phase, 100...120V Input						
Code	Amps	Frame	ND		HD	
			HP	kW	HP	kW
2P5	2.5	A	0.5	0.4	0.5	0.4
4P8	4.8	B	1.0	0.75	1.0	0.75
6P0	6.0	B	1.5	1.1	1.5	1.1

Output Current @ 1 Phase, 200...240V Input						
Code	Amps	Frame	ND		HD	
			HP	kW	HP	kW
2P5	2.5	A	0.5	0.4	0.5	0.4
4P8	4.8	A	1.0	0.75	1.0	0.75
8P0	8.0	B	2.0	1.5	2.0	1.5
011	11.0	B	3.0	2.2	3.0	2.2

Output Current @ 3Phase, 200...240V Input						
Code	Amps	Frame	ND		HD	
			HP	kW	HP	kW
2P5	2.5	A	0.5	0.4	0.5	0.4
5P0	5.0	A	1.0	0.75	1.0	0.75
8P0	8.0	A	2.0	1.5	2.0	1.5
011	11.0	A	3.0	2.2	3.0	2.2
017	17.5	B	5.0	4.0	5.0	4.0
024	24.0	C	7.5	5.5	7.5	5.5
032	32.2	D	10.0	7.5	10.0	7.5
048 ⁽¹⁾	48.3	E	15.0	11.0	10.0	7.5
062 ⁽¹⁾	62.1	E	20.0	15.0	15.0	11.0

Output Current @ 3 Phase, 380...480V Input						
Code	Amps	Frame	ND		HD	
			HP	kW	HP	kW
1P4	1.4	A	0.5	0.4	0.5	0.4
2P3	2.3	A	1.0	0.75	1.0	0.75
4P0	4.0	A	2.0	1.5	2.0	1.5
6P0	6.0	A	3.0	2.2	3.0	2.2
010	10.5	B	5.0	4.0	5.0	4.0
013	13.0	C	7.5	5.5	7.5	5.5
017	17.0	C	10.0	7.5	10.0	7.5
024	24.0	D	15.0	11.0	15.0	11.0
030 ⁽¹⁾	30.0	D	20.0	15.0	15.0	11.0
037 ⁽¹⁾	37.0	E	25.0	18.5	20.0	15.0
043 ⁽¹⁾	43.0	E	30.0	22.0	25.0	18.5

Output Current @ 3 Phase, 525...600V Input						
Code	Amps	Frame	ND		HD	
			HP	kW	HP	kW
0P9	0.9	A	0.5	0.4	0.5	0.4
1P7	1.7	A	1.0	0.75	1.0	0.75
3P0	3.0	A	2.0	1.5	2.0	1.5
4P2	4.2	A	3.0	2.2	3.0	2.2
6P6	6.6	B	5.0	4.0	5.0	4.0
9P9	9.9	C	7.5	5.5	7.5	5.5
012	12.0	C	10.0	7.5	10.0	7.5
019	19.0	D	15.0	11.0	15.0	11.0
022 ⁽¹⁾	22.0	D	20.0	15.0	15.0	11.0
027 ⁽¹⁾	27.0	E	25.0	18.5	20.0	15.0
032 ⁽¹⁾	32.0	E	30.0	22.0	25.0	18.5

(1) Normal and Heavy Duty ratings are available for this drive.

Installation/Wiring

This chapter provides information on mounting and wiring the PowerFlex 527 drives.

For information on...	See page...
Mounting Considerations	11
AC Supply Source Considerations	15
General Grounding Requirements	16
Fuses and Circuit Breakers	18
Power and Control Module	23
Control Module Cover	26
Power Module Terminal Guard	26
Power Wiring	27
Power Terminal Block	30
I/O Wiring	30
Control I/O Terminal Block	32
CE Conformity	34

Most start-up difficulties are the result of incorrect wiring. Every precaution must be taken to assure that the wiring is done as instructed. All items must be read and understood before the actual installation begins.



ATTENTION: The following information is merely a guide for proper installation. Rockwell Automation cannot assume responsibility for the compliance or the noncompliance to any code, national, local or otherwise for the proper installation of this drive or associated equipment. A hazard of personal injury and/or equipment damage exists if codes are ignored during installation.

Mounting Considerations

- Mount the drive upright on a flat, vertical and level surface.

Frame	Screw Size	Screw Torque
A	M5 (#10...24)	1.56...1.96 Nm (14...17 lb-in.)
B	M5 (#10...24)	1.56...1.96 Nm (14...17 lb-in.)
C	M5 (#10...24)	1.56...1.96 Nm (14...17 lb-in.)
D	M5 (#10...24)	2.45...2.94 Nm (22...26 lb-in.)
E	M8 (5/16 in.)	6.0...7.4 Nm (53...65 lb-in.)

- Protect the cooling fan by avoiding dust or metallic particles.
- Do not expose to a corrosive atmosphere.
- Protect from moisture and direct sunlight.

Minimum Mounting Clearances

See [Appendix B](#) for mounting dimensions.

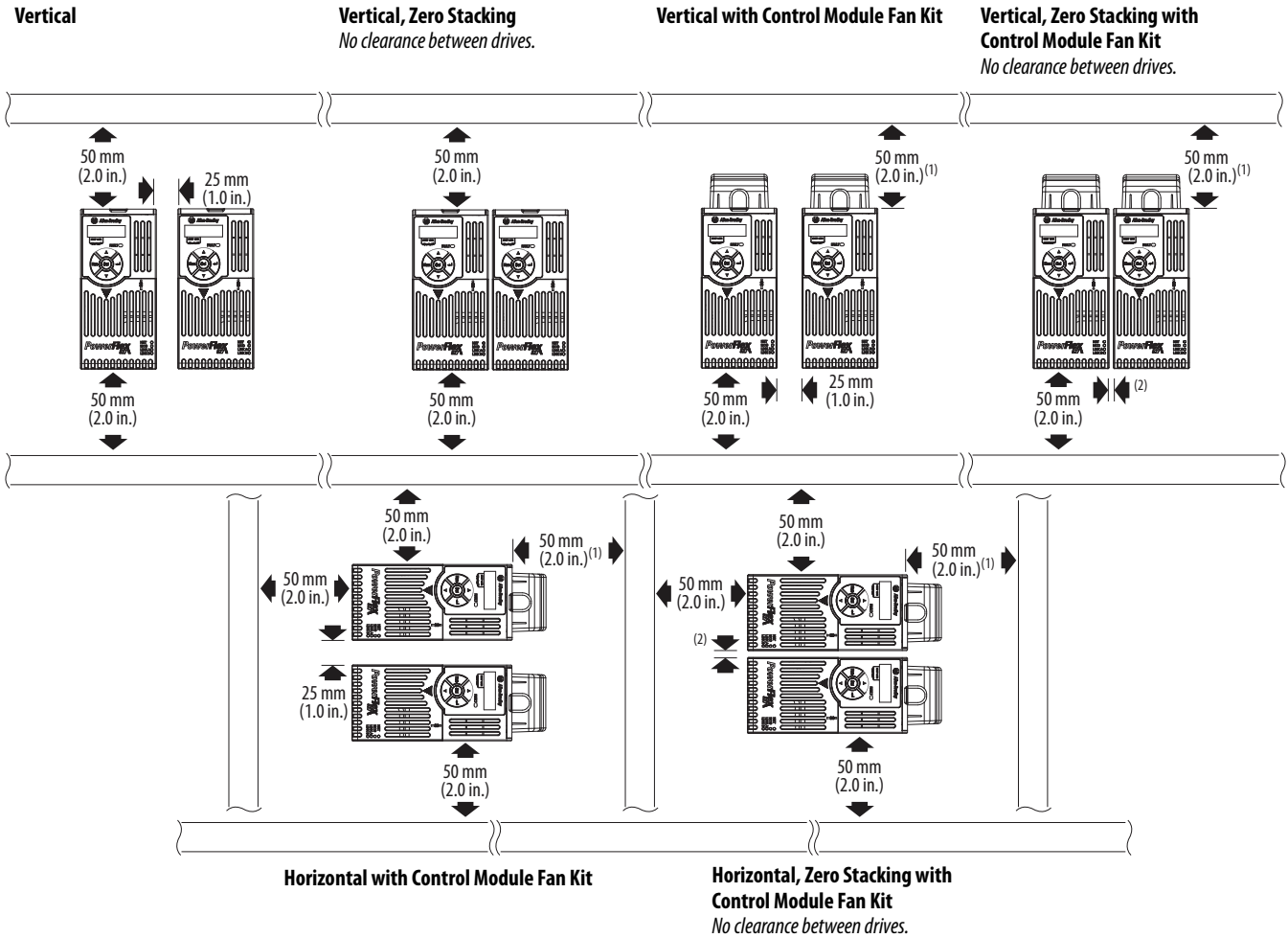

- (1) For Frame E with Control Module Fan Kit only, clearance of 95 mm (3.7 in.) is required.
- (2) For Frame E with Control Module Fan Kit only, clearance of 12 mm (0.5 in.) is required.

Ambient Operating Temperatures

See [Appendix B](#) for option kits.

Mounting	Enclosure Rating ⁽¹⁾	Ambient Temperature			
		Minimum	Maximum (No Derate)	Maximum (Derate) ⁽²⁾	Maximum with Control Module Fan Kit (Derate) ⁽³⁾⁽⁵⁾
Vertical	IP 20/Open Type	-20 °C (-4 °F)	50 °C (122 °F)	—	70 °C (158 °F)
	IP 30/NEMA 1/UL Type 1		45 °C (113 °F)	55 °C (131 °F)	—
Vertical, Zero Stacking	IP 20/Open Type		45 °C (113 °F)	—	65 °C (149 °F)
Horizontal with Control Module Fan Kit ⁽⁴⁾⁽⁵⁾	IP 20/Open Type		50 °C (122 °F)	—	70 °C (158 °F)
Horizontal, Zero Stacking with Control Module Fan Kit ⁽⁴⁾⁽⁵⁾	IP 20/Open Type		45 °C (113 °F)	—	65 °C (149 °F)

- (1) IP 30/NEMA 1/UL Type 1 rating requires installation of the PowerFlex 520-Series IP 30/NEMA 1/UL Type 1 option kit, catalog number 25-JBAX.
- (2) For catalogs 25C-D1P4N104 and 25C-E0P9N104, the temperature listed under the Maximum (Derate) column is reduced by 5 °C (9 °F) for all mounting methods.
- (3) For catalogs 25C-D1P4N104 and 25C-E0P9N104, the temperature listed under the Maximum with Control Module Fan Kit (Derate) column is reduced by 10 °C (18 °F) for vertical and vertical with zero stacking mounting methods only.
- (4) Catalogs 25C-D1P4N104 and 25C-E0P9N104 cannot be mounted using either of the horizontal mounting methods.
- (5) Requires installation of the PowerFlex 520-Series Control Module Fan Kit, catalog number 25-FANx-70C.

Current Derating Curves

Vertical Mounting

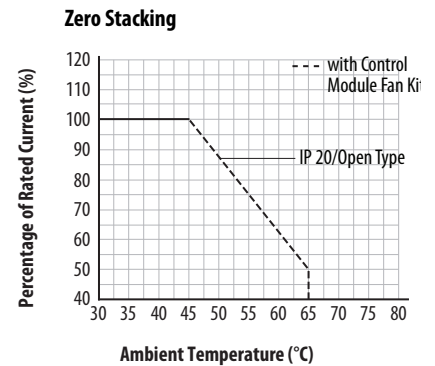
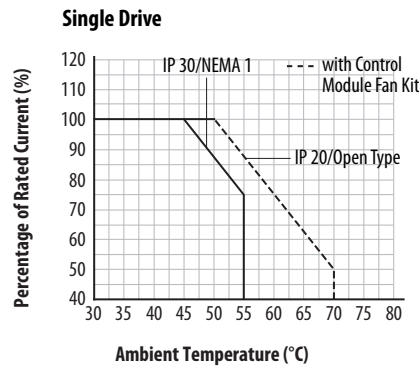

Horizontal/Floor Mounting

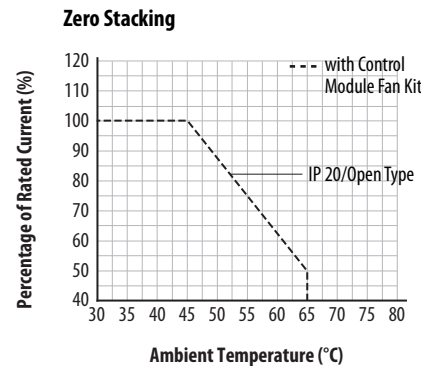
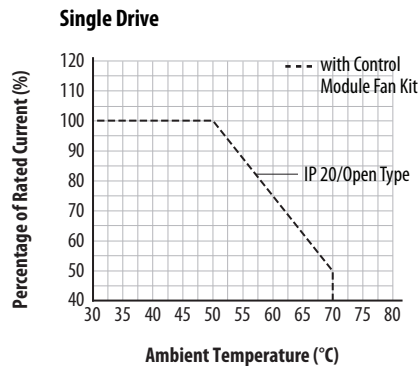

Derating Guidelines for High Altitude

The drive can be used without derating at a maximum altitude of 1000 m (3300 ft). If the drive is used above 1000 m (3300 ft):

- Derate the maximum ambient temperature by 5 °C (9 °F) for every additional 1000 m (3300 ft), subject to limits listed in the [Altitude Limit \(Based on Voltage\)](#) table below.
- Or
- Derate the output current by 10% for every additional 1000 m (3300 ft), up to 3000 m (9900 ft), subject to limits listed in the [Altitude Limit \(Based on Voltage\)](#) table below.

Altitude Limit (Based on Voltage)

Drive Rating	Center Ground (Wye Neutral)	Corner Ground, Impedance Ground, or Ungrounded
100...120V 1-Phase	6000 m	6000 m
200...240V 1-Phase	2000 m	2000 m
200...240V 3-Phase	6000 m	2000 m
380...480V 3-Phase	4000 m	2000 m
525...600V 3-Phase	2000 m	2000 m

High Altitude

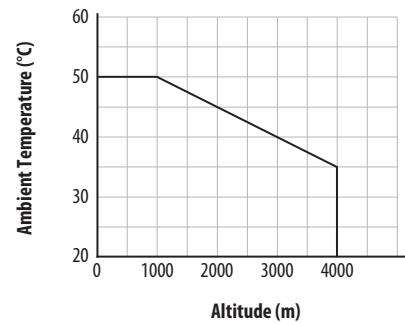
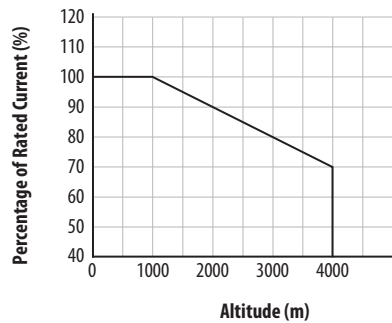

Debris Protection

Take precautions to prevent debris from falling through the vents of the drive housing during installation.

Storage

- Store within an ambient temperature range of -40...85°C⁽¹⁾.
- Store within a relative humidity range of 0...95%, noncondensing.
- Do not expose to a corrosive atmosphere.

(1) The maximum ambient temperature for storing a Frame E drive is 70 °C.

AC Supply Source Considerations

Ungrounded Distribution Systems



ATTENTION: PowerFlex 527 drives contain protective MOVs that are referenced to ground. These devices must be disconnected if the drive is installed on an ungrounded or resistive grounded distribution system.

ATTENTION: Removing MOVs in drives with an embedded filter will also disconnect the filter capacitor from earth ground.

Disconnecting MOVs

To prevent drive damage, the MOVs connected to ground shall be disconnected if the drive is installed on an ungrounded distribution system (IT mains) where the line-to-ground voltages on any phase could exceed 125% of the nominal line-to-line voltage. To disconnect these devices, remove the jumper shown in the diagrams below.

1. Turn the screw counterclockwise to loosen.
2. Pull the jumper completely out of the drive chassis.
3. Tighten the screw to keep it in place.

Jumper Location (Typical)

Power module

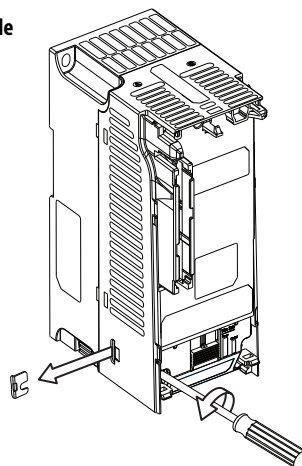

IMPORTANT Tighten screw after jumper removal.

Phase to Ground MOV Removal

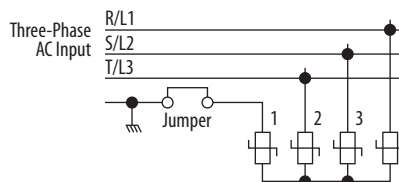

Input Power Conditioning

The drive is suitable for direct connection to input power within the rated voltage of the drive (see [Technical Specifications on page 133](#)). Listed in the [Input Power Conditions](#) table below are certain input power conditions which may cause component damage or reduction in product life. If any of these conditions exist, install one of the devices listed under the heading Corrective Action on the line side of the drive.

IMPORTANT Only one device per branch circuit is required. It should be mounted closest to the branch and sized to handle the total current of the branch circuit.

Input Power Conditions

Input Power Condition	Corrective Action
Low Line Impedance (less than 1% line reactance)	<ul style="list-style-type: none"> • Install Line Reactor⁽²⁾ • or Isolation Transformer
Greater than 120 kVA supply transformer	
Line has power factor correction capacitors	<ul style="list-style-type: none"> • Install Line Reactor⁽²⁾ • or Isolation Transformer
Line has frequent power interruptions	
Line has intermittent noise spikes in excess of 6000V (lightning)	
Phase to ground voltage exceeds 125% of normal line to line voltage	<ul style="list-style-type: none"> • Remove MOV jumper to ground. • or Install Isolation Transformer with grounded secondary if necessary.
Ungrounded distribution system	
240V open delta configuration (stinger leg) ⁽¹⁾	<ul style="list-style-type: none"> • Install Line Reactor⁽²⁾

(1) For drives applied on an open delta with a middle phase grounded neutral system, the phase opposite the phase that is tapped in the middle to the neutral or earth is referred to as the “stinger leg,” “high leg,” “red leg,” etc. This leg should be identified throughout the system with red or orange tape on the wire at each connection point. The stinger leg should be connected to the center Phase B on the reactor. See [Bulletin 1321-3R Series Line Reactors on page 145](#) for specific line reactor part numbers.

(2) See [Appendix B](#) for accessory ordering information.

General Grounding Requirements

The drive Safety Ground - \ominus (PE) must be connected to system ground. Ground impedance must conform to the requirements of national and local industrial safety regulations and/or electrical codes. The integrity of all ground connections should be periodically checked.

Typical Grounding

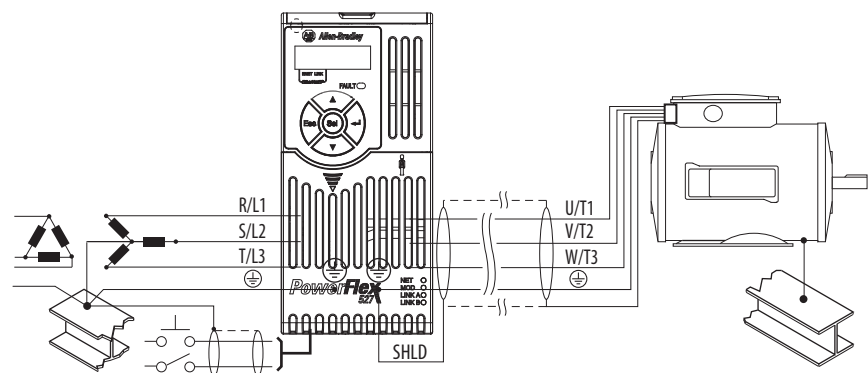

Ground Fault Monitoring

If a system ground fault monitor (RCD) is to be used, only Type B (adjustable) devices should be used to avoid nuisance tripping.

Safety Ground - (PE)

This is the safety ground for the drive that is required by code. One of these points must be connected to adjacent building steel (girder, joist), a floor ground rod or bus bar. Grounding points must comply with national and local industrial safety regulations and/or electrical codes.

Motor Ground

The motor ground must be connected to one of the ground terminals on the drive.

Shield Termination - SHLD

Either of the safety ground terminals located on the power terminal block provides a grounding point for the motor cable shield. The **motor cable** shield connected to one of these terminals (drive end) should also be connected to the motor frame (motor end). Use a shield terminating or EMI clamp to connect the shield to the safety ground terminal. The earthing plate or conduit box option may be used with a cable clamp for a grounding point for the cable shield.

When shielded cable is used for **control and signal wiring**, the shield should be grounded at the source end only, not at the drive end.

RFI Filter Grounding

Using a drive with filter may result in relatively high ground leakage currents. Therefore, the **filter must only be used in installations with grounded AC supply systems and be permanently installed and solidly grounded** (bonded) to the building power distribution ground. Ensure that the incoming supply neutral is solidly connected (bonded) to the same building power distribution ground. Grounding must not rely on flexible cables and should not include any form of plug or socket that would permit inadvertent disconnection. Some local codes may require redundant ground connections. The integrity of all connections should be periodically checked.

Fuses and Circuit Breakers

The PowerFlex 527 drive does not provide branch short circuit protection. This product should be installed with either input fuses or an input circuit breaker. National and local industrial safety regulations and/or electrical codes may determine additional requirements for these installations.

The tables under [Fuses and Circuit Breakers for PowerFlex 527 on page 19](#) provide recommended AC line input fuse and circuit breaker information. See Fusing and Circuit Breakers below for UL and IEC requirements. Sizes listed are the recommended sizes based on 40 °C (104 °F) and the U.S. N.E.C. Other country, state or local codes may require different ratings.

Fusing

The recommended fuse types are listed in the tables found on [Fuses and Circuit Breakers for PowerFlex 527 on page 19](#). If available current ratings do not match those listed in the tables provided, choose the next higher fuse rating.

- IEC – BS88 (British Standard) Parts 1 & 2⁽¹⁾, EN60269-1, Parts 1 & 2, type GG or equivalent should be used.
- UL – UL Class CC, T, RK1, or J should be used.

Circuit Breakers

The “non-fuse” listings in the tables [Fuses and Circuit Breakers for PowerFlex 527 on page 19](#) include inverse time circuit breakers, instantaneous trip circuit breakers (motor circuit protectors) and 140M self-protected combination motor controllers. If one of these is chosen as the desired protection method, the following requirements apply:

- IEC – Both types of circuit breakers and 140M self-protected combination motor controllers are acceptable for IEC installations.
- UL – Only inverse time circuit breakers and the specified 140M self-protected combination motor controllers are acceptable for UL installations.

Bulletin 140M (Self-Protected Combination Controller)/UL489 Circuit Breakers

When using Bulletin 140M or UL489 rated circuit breakers, the guidelines listed below must be followed in order to meet the NEC requirements for branch circuit protection.

- Bulletin 140M can be used in single motor applications.
- Bulletin 140M can be used up stream from the drive **without** the need for fuses.

If the DC Bus terminals or the Dynamic Brake terminals are used, the drive must be installed in an enclosure and fuses must be used for input protection (for CE applications only). The ventilated enclosure needs to be IP 20 rating or higher and at least 1.5x size larger than the drive.

(1) Typical designations include, but may not be limited to the following:
Parts 1 & 2: AC, AD, BC, BD, CD, DD, ED, EFS, EF, FF, FG, GF, GG, GH.

Fuses and Circuit Breakers for PowerFlex 527

100... 120V 1-Phase Input Protection Devices – Frames A...B

Catalog No.	Output Ratings				Input Ratings		IEC (Non-UL Applications)			UL Applications						
	Normal Duty		Heavy Duty		Amps	kVA	Max Amps ⁽¹⁾	Frame Size	Contactor Catalog No.	Fuses		Circuit Breakers				
	HP	kW	HP	kW						Min. Rating	Max. Rating	140U	140M	Class / Catalog No.	Circuit Breakers	
25C-V2P5N104	0.5	0.4	0.5	0.4	2.5	1.3	9.6	A	100-C12	15	20	140U-D6D2-C12	140M-CZE-C10	CLASS RK5, CC, J, or T / DLS-R-20	140U-D6C2-C12	140M ⁽²⁾⁽³⁾⁽⁴⁾
25C-V4P8N104	1.0	0.75	1.0	0.75	4.8	2.5	19.2	B	100-C23	25	40	140U-D6D2-C25	140M-D8E-C20	CLASS RK5, CC, J, or T / DLS-R-40	140U-D6D2-C25	140M-D8E-C20
25C-V6P0N104	1.5	1.1	1.5	1.1	6.0	3.2	24.0	B	100-C23	30	50	140U-D6D2-C30	140M-F8E-C25	CLASS RK5, CC, J, or T / DLS-R-50	140U-D6D2-C30	140M-F8E-C25

200...240V 1-Phase Input Protection Devices – Frames A...B

Catalog No.	Output Ratings				Input Ratings		IEC (Non-UL Applications)			UL Applications						
	Normal Duty		Heavy Duty		Amps	kVA	Max Amps ⁽¹⁾	Frame Size	Contactor Catalog No.	Fuses		Circuit Breakers				
	HP	kW	HP	kW						Min. Rating	Max. Rating	140U	140M	Class / Catalog No.	Circuit Breakers	
25C-A2P5N104	0.5	0.4	0.5	0.4	2.5	1.7	6.5	A	100-C09	10	15	140U-D6D2-C10	140M-CZE-C10	CLASS RK5, CC, J, or T / DLS-R-15	140U-D6D2-C10	140M-CZE-C10
25C-A2P5N114	0.5	0.4	0.5	0.4	2.5	1.7	6.5	A	100-C09	10	15	140U-D6D2-C10	140M-CZE-C10	CLASS RK5, CC, J, or T / DLS-R-15	140U-D6D2-C10	140M-CZE-C10
25C-A4P8N104	1.0	0.75	1.0	0.75	4.8	2.8	10.7	A	100-C12	15	25	140U-D6D2-C15	140M-CZE-C16	CLASS RK5, CC, J, or T / DLS-R-25	140U-D6D2-C15	140M-CZE-C16
25C-A4P8N114	1.0	0.75	1.0	0.75	4.8	2.8	10.7	A	100-C12	15	25	140U-D6D2-C15	140M-CZE-C16	CLASS RK5, CC, J, or T / DLS-R-25	140U-D6D2-C15	140M-CZE-C16
25C-A8P0N104	2.0	1.5	2.0	1.5	8.0	4.8	18.0	B	100-C23	25	40	140U-D6D2-C25	140M-F8E-C25	CLASS CC, J, or T / 40	140U-D6D2-C25	140M-F8E-C25
25C-A8P0N114	2.0	1.5	2.0	1.5	8.0	4.8	18.0	B	100-C23	25	40	140U-D6D2-C25	140M-F8E-C25	CLASS CC, J, or T / 40	140U-D6D2-C25	140M-F8E-C25
25C-A0T1N104	3.0	2.2	3.0	2.2	11.0	6.0	22.9	B	100-C37	30	50	140U-H6C2-C35	140M-F8E-C25	CLASS CC, J, or T / 50	140U-H6C2-C35	140M-F8E-C25
25C-A0T1N114	3.0	2.2	3.0	2.2	11.0	6.0	22.9	B	100-C37	30	50	140U-H6C2-C35	140M-F8E-C25	CLASS CC, J, or T / 50	140U-H6C2-C35	140M-F8E-C25

- (1) When the drive is controlling motors with lower amp ratings, refer to the drive nameplate for drive input current rating.
- (2) The AIC ratings of the Bulletin 140M Motor Protector Circuit Breakers may vary. See [Bulletin 140M Motor Protection Circuit Breakers Application Ratings](#).
- (3) Bulletin 140M with adjustable current range should have the current trip set to the minimum range that the device will not trip.
- (4) Manual Self-Protected (Type E) Combination Motor Controller, UL listed for 480V/277 and 600Y/347 AC input. Not UL listed for use on 480V or 600V Delta/Delta, corner ground, or high-resistance ground systems.

Fuses and Circuit Breakers for PowerFlex 527 (continued)

200...240V 3-Phase Input Protection Devices – Frames A...E

Catalog No. (1)	Output Ratings				Input Ratings			IEC (Non-UL Applications)			UL Applications				
	Normal Duty		Heavy Duty		Amps	kVA	Max Amps ⁽²⁾	Frame Size	Contactor Catalog No.	Circuit Breakers		Fuses (Max. Rating)			
	HP	kW	HP	kW						140U	140M	Class / Catalog No.	Circuit Breakers		
25C-B2P5N104	0.5	0.4	0.5	0.4	2.5	1.2	2.7	A	100-C07	6	140U-D6D3-B40	140M-CZE-B40	CLASS RK5, CC, J, or T / DLS-R-6	140U	140M ⁽³⁾⁽⁴⁾⁽⁵⁾
25C-B5P0N104	1.0	0.75	1.0	0.75	5.0	2.7	5.8	A	100-C09	10	140U-D6D3-B80	140M-CZE-B63	CLASS RK5, CC, J, or T / DLS-R-15	140U-D6D3-B40	140M-CZE-B40
25C-B8P0N104	2.0	1.5	2.0	1.5	8.0	4.3	9.5	A	100-C12	15	140U-D6D3-C10	140M-CZE-C10	CLASS RK5, CC, J, or T / DLS-R-20	140U-D6D3-B80	140M-CZE-B63
25C-B011N104	3.0	2.2	3.0	2.2	11.0	6.3	13.8	A	100-C23	20	140U-D6D3-C15	140M-CZE-C16	CLASS RK5, CC, J, or T / DLS-R-30	140U-D6D3-C10	140M-CZE-C10
25C-B017N104	5.0	4.0	5.0	4.0	17.5	9.6	21.1	B	100-C23	30	140U-D6D3-C25	140M-F8E-C25	CLASS RK5, CC, J, or T / 45	140U-D6D3-C15	140M-F8E-C25
25C-B024N104	7.5	5.5	7.5	5.5	24.0	12.2	26.6	C	100-C37	35	140U-H6C3-C35	140M-F8E-C32	CLASS CC, J, or T / 60	140U-H6C3-C35	140M-F8E-C32
25C-B032N104	10.0	7.5	10.0	7.5	32.2	15.9	34.8	D	100-C43	45	140U-H6C3-C60	140M-F8E-C45	CLASS RK5, CC, J, or T / DLS-R-70	—	140M-F8E-C45
25C-B048N104	15.0	11.0	10.0	7.5	48.3	20.1	44.0	E	100-C60	60	140U-H6C3-C70	140M-F8E-C45	CLASS CC, J, or T / 90	—	140M-F8E-C45
25C-B062N104	20.0	15.0	15.0	11.0	62.1	25.6	56.0	E	100-C72	70	140U-H6C3-C90	140M-H8P-C70	CLASS CC, J, or T / 125	—	140M-H8P-C70

- (1) — Normal and Heavy duty ratings are available for this drive.
- (2) When the drive is controlling motors with lower amp ratings, refer to the drive nameplate for drive input current rating.
- (3) The AIC ratings of the Bulletin 140M Motor Protector Circuit Breakers may vary. See [Bulletin 140M Motor Protection Circuit Breakers Application Ratings](#).
- (4) Bulletin 140M with adjustable current range should have the current trip set to the minimum range that the device will not trip.
- (5) Manual Self-Protected (Type E) Combination Motor Controller, UL listed for 480Y/277 and 600Y/347 AC input. Not UL listed for use on 480V or 600V Delta/Delta, corner ground, or high-resistance ground systems.

Fuses and Circuit Breakers for PowerFlex 527 (continued)

380...480V 3-Phase Input Protection Devices – Frames A...E

Catalog No. (1)	Output Ratings				Input Ratings			IEC (Non-UL Applications)			UL Applications					
	Normal Duty HP	Normal Duty kW	Heavy Duty HP	Heavy Duty kW	Amps	kVA	Max Amps ⁽²⁾	Frame Size	Contactor Catalog No.	Fuses		Circuit Breakers				
										Min. Rating	Max. Rating	140U	140M	Class / Catalog No.	140U	
25C-D1P4N104	0.5	0.4	0.5	0.4	1.4	1.7	1.9	A	100-C07	3	6	140U-D6D3-B30	140M-CZE-B25	CLASS RK5, CC, J, or T / DLS-R-6	140U	140M ⁽³⁾⁽⁴⁾⁽⁵⁾
25C-D1P4N114	0.5	0.4	0.5	0.4	1.4	1.7	1.9	A	100-C07	3	6	140U-D6D3-B30	140M-CZE-B25	CLASS RK5, CC, J, or T / DLS-R-6	–	140M-CZE-B25
25C-D2P3N104	1.0	0.75	1.0	0.75	2.3	2.9	3.2	A	100-C07	6	10	140U-D6D3-B60	140M-CZE-B40	CLASS RK5, CC, J, or T / DLS-R-10	–	140M-CZE-B40
25C-D2P3N114	1.0	0.75	1.0	0.75	2.3	2.9	3.2	A	100-C07	6	10	140U-D6D3-B60	140M-CZE-B40	CLASS RK5, CC, J, or T / DLS-R-10	–	140M-CZE-B40
25C-D4P0N104	2.0	1.5	2.0	1.5	4.0	5.2	5.7	A	100-C09	10	15	140U-D6D3-B60	140M-CZE-B63	CLASS RK5, CC, J, or T / DLS-R-15	–	140M-CZE-B63
25C-D4P0N114	2.0	1.5	2.0	1.5	4.0	5.2	5.7	A	100-C09	10	15	140U-D6D3-B60	140M-CZE-B63	CLASS RK5, CC, J, or T / DLS-R-15	–	140M-CZE-B63
25C-D6P0N104	3.0	2.2	3.0	2.2	6.0	6.9	7.5	A	100-C09	10	15	140U-D6D3-C10	140M-CZE-C10	CLASS RK5, CC, J, or T / DLS-R-15	–	140M-CZE-C10
25C-D6P0N114	3.0	2.2	3.0	2.2	6.0	6.9	7.5	A	100-C09	10	15	140U-D6D3-C10	140M-CZE-C10	CLASS RK5, CC, J, or T / DLS-R-15	–	140M-CZE-C10
25C-D0T0N104	5.0	4.0	5.0	4.0	10.5	12.6	13.8	B	100-C23	20	30	140U-D6D3-C15	140M-CZE-C16	CLASS RK5, CC, J, or T / DLS-R-30	–	140M-CZE-C16
25C-D0T0N114	5.0	4.0	5.0	4.0	10.5	12.6	13.8	B	100-C23	20	30	140U-D6D3-C15	140M-CZE-C16	CLASS RK5, CC, J, or T / DLS-R-30	–	140M-CZE-C16
25C-D0T3N104	7.5	5.5	7.5	5.5	13.0	14.1	15.4	C	100-C23	20	35	140U-D6D3-C25	140M-D8E-C20	CLASS CC, J, or T / 35	–	140M-D8E-C20
25C-D0T3N114	7.5	5.5	7.5	5.5	13.0	14.1	15.4	C	100-C23	20	35	140U-D6D3-C25	140M-D8E-C20	CLASS CC, J, or T / 35	–	140M-D8E-C20
25C-D0T7N104	10.0	7.5	10.0	7.5	17.0	16.8	18.4	C	100-C23	25	40	140U-D6D3-C25	140M-D8E-C20	CLASS CC, J, or T / 40	–	140M-D8E-C20
25C-D0T7N114	10.0	7.5	10.0	7.5	17.0	16.8	18.4	C	100-C23	25	40	140U-D6D3-C25	140M-D8E-C20	CLASS CC, J, or T / 40	–	140M-D8E-C20
25C-D0Z4N104	15.0	11.0	15.0	11.0	24.0	24.1	26.4	D	100-C37	35	60	140U-H6C3-C40	140M-F8E-C32	CLASS CC, J, or T / 60	–	140M-F8E-C32
25C-D0Z4N114	15.0	11.0	15.0	11.0	24.0	24.1	26.4	D	100-C37	35	60	140U-H6C3-C40	140M-F8E-C32	CLASS CC, J, or T / 60	–	140M-F8E-C32
25C-D0Z0N104	20.0	15.0	20.0	15.0	30.0	30.2	33.0	D	100-C43	45	70	140U-H6C3-C50	140M-F8E-C45	CLASS CC, J, or T / 70	–	140M-F8E-C45
25C-D0Z0N114	20.0	15.0	20.0	15.0	30.0	30.2	33.0	D	100-C43	45	70	140U-H6C3-C50	140M-F8E-C45	CLASS CC, J, or T / 70	–	140M-F8E-C45
25C-D0Z7N114	25.0	18.5	20.0	15.0	37.0	30.8	33.7	E	100-C43	45	70	140U-H6C3-C50	140M-F8E-C45	CLASS CC, J, or T / 70	–	140M-F8E-C45
25C-D0Z3N114	30.0	22.0	25.0	18.5	43.0	35.6	38.9	E	100-C60	50	80	140U-H6C3-C60	140M-F8E-C45	CLASS CC, J, or T / 80	–	140M-F8E-C45

(1) Normal and Heavy duty ratings are available for this drive.
 (2) When the drive is controlling motors with lower amp ratings, refer to the drive nameplate for drive input current rating.
 (3) The AIC ratings of the Bulletin 140M Motor Protector Circuit Breakers may vary. See [Bulletin 140M Motor Protection Circuit Breakers Application Ratings](#).
 (4) Bulletin 140M with adjustable current range should have the current trip set to the minimum range that the device will not trip.
 (5) Manual Self-Protected (Type E) Combination Motor Controller, UL listed for 480Y/277 and 600Y/347 AC input. Not UL listed for use on 480V or 600V Delta/Delta, corner ground, or high-resistance ground systems.

Fuses and Circuit Breakers for PowerFlex 527 (continued)

525...600V 3-Phase Input Protection Devices – Frames A...E

Catalog No. (1)	Output Ratings				Input Ratings			IEC (Non-UL Applications)			UL Applications						
	HP	kW	HP	kW	Amps	kVA	Max Amps ⁽²⁾	Frame Size	Contactor Catalog No.	Fuses		Circuit Breakers		Fuses (Max. Rating)		Circuit Breakers	
										Min. Rating	Max. Rating	140U	140M	Class / Catalog No.	Class / Catalog No.		
25C-E0P9N104	0.5	0.4	0.5	0.4	0.9	1.4	1.2	A	100-C09	3	6	140U-D6D3-B20	140M-CZE-B25	CLASS RK5, CC, J, or T / DLS-R-6	CLASS RK5, CC, J, or T / DLS-R-6	140U	140M ⁽³⁾⁽⁴⁾⁽⁵⁾
25C-E1P7N104	1.0	0.75	1.0	0.75	1.7	2.6	2.3	A	100-C09	3	6	140U-D6D3-B30	140M-CZE-B25	CLASS RK5, CC, J, or T / DLS-R-6	CLASS RK5, CC, J, or T / DLS-R-6	–	140M-CZE-B25
25C-E3P0N104	2.0	1.5	2.0	1.5	3.0	4.3	3.8	A	100-C09	6	10	140U-D6D3-B50	140M-CZE-B40	CLASS RK5, CC, J, or T / DLS-R-10	CLASS RK5, CC, J, or T / DLS-R-10	–	140M-CZE-B40
25C-E4P2N104	3.0	2.2	3.0	2.2	4.2	6.1	5.3	A	100-C09	10	15	140U-D6D3-B80	140M-CZE-B63	CLASS RK5, CC, J, or T / DLS-R-15	CLASS RK5, CC, J, or T / DLS-R-15	–	140M-D8E-B63
25C-E6P6N104	5.0	4.0	5.0	4.0	6.6	9.1	8.0	B	100-C09	10	20	140U-D6D3-C10	140M-CZE-C10	CLASS RK5, CC, J, or T / DLS-R-20	CLASS RK5, CC, J, or T / DLS-R-20	–	140M-D8E-C10
25C-E9P9N104	7.5	5.5	7.5	5.5	9.9	12.8	11.2	C	100-C16	15	25	140U-D6D3-C15	140M-CZE-C16	CLASS RK5, CC, J, or T / DLS-R-25	CLASS RK5, CC, J, or T / DLS-R-25	–	140M-D8E-C16 ⁽⁶⁾
25C-E0T2N104	10.0	7.5	10.0	7.5	12.0	15.4	13.5	C	100-C23	20	30	140U-D6D3-C20	140M-CZE-C16	CLASS RK5, CC, J, or T / DLS-R-30	CLASS RK5, CC, J, or T / DLS-R-30	–	140M-D8E-C16
25C-E0T9N104	15.0	11.0	15.0	11.0	19.0	27.4	24.0	D	100-C30	30	50	140U-H6C3-C30	140M-F8E-C25	CLASS CC, J, or T / 50	CLASS CC, J, or T / 50	–	140M-F8E-C25
25C-E0Z2N104	20.0	15.0	15.0	11.0	22.0	31.2	27.3	D	100-C30	35	60	140U-H6C3-C35	140M-F8E-C32	CLASS CC, J, or T / 60	CLASS CC, J, or T / 60	–	140M-F8E-C32
25C-E0Z7N104	25.0	18.5	20.0	15.0	27.0	28.2	24.7	E	100-C30	35	50	140U-H6C3-C35	140M-F8E-C32	CLASS CC, J, or T / 50	CLASS CC, J, or T / 50	–	140M-F8E-C32
25C-E0Z2N104	30.0	22.0	25.0	18.5	32.0	33.4	29.2	E	100-C37	40	60	140U-H6C3-C50	140M-F8E-C32	CLASS CC, J, or T / 60	CLASS CC, J, or T / 60	–	140M-F8E-C32

- (1) Normal and Heavy duty ratings are available for this drive.
- (2) When the drive is controlling motors with lower amp ratings, refer to the drive nameplate for drive input current rating.
- (3) The AIC ratings of the Bulletin 140M Motor Protector Circuit Breakers may vary. See [Bulletin 140M Motor Protection Circuit Breakers Application Ratings](#).
- (4) Bulletin 140M with adjustable current range should have the current trip set to the minimum range that the device will not trip.
- (5) Manual Self-Protected (Type E) Combination Motor Controller, UL listed for 480V/277 and 600V/347 AC input. Not UL listed for use on 480V or 600V Delta/Delta, corner ground, or high-resistance ground systems.
- (6) When used with the 140M circuit breaker, the 25C-E9P9104 must be installed in a ventilated or non-ventilated enclosure with the minimum size of 457.2 x 457.2 x 269.8 mm (18 x 18 x 10.62 in.).

Power and Control Module

PowerFlex 527 drives consist of a Power Module and Control Module. This section describes how to separate the two modules and reconnect them back together, and also how to access the power terminals and control terminals. It is assumed that your drive is new and has not been installed.



ATTENTION: If you are performing these steps on a drive that has been installed, ensure that the drive is powered down and the DC Bus voltage is less than 50V DC before proceeding.

Separating the Power and Control Module

1. Press and hold down the catch on both sides of the frame cover, then pull out and swing upwards to remove (Frames B...E only).

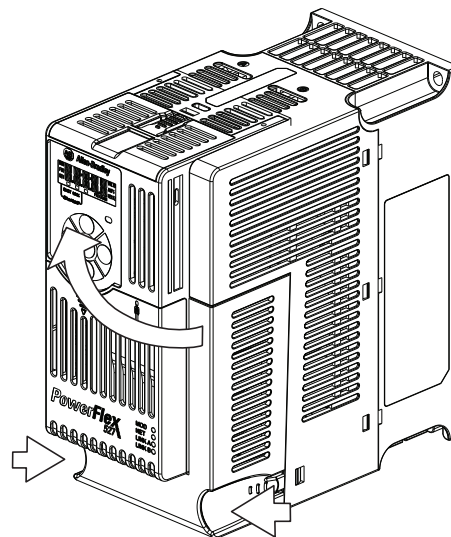

2. Press down and slide out the top cover of the Control Module to unlock it from the Power Module.

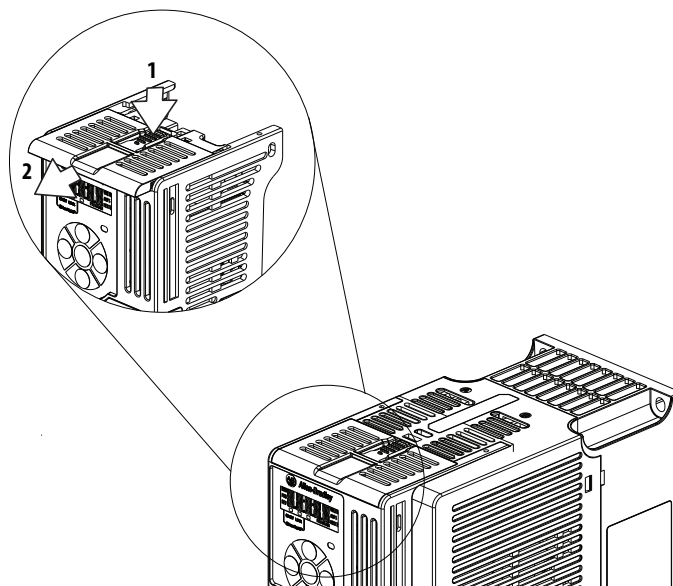

3. Hold the sides and top of the Control Module firmly, then pull out to separate it from the Power Module.

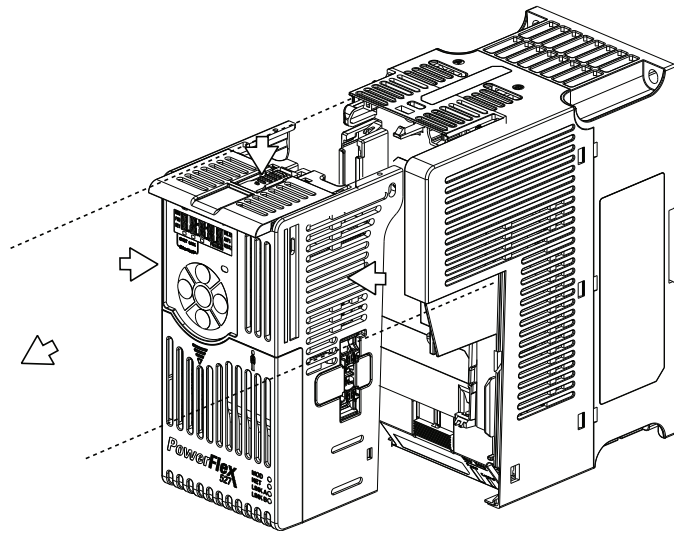

Connecting the Power and Control Module

1. Align the connectors on the Power Module and Control Module, then push the Control Module firmly onto the Power Module.

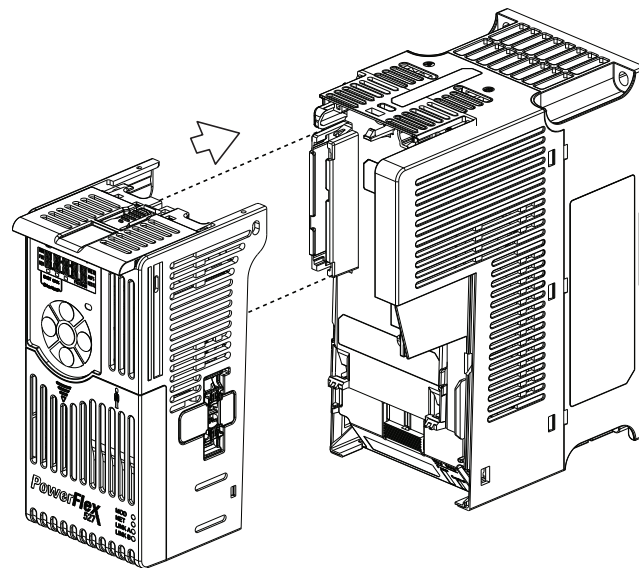

- 2. Push the top cover of the Control Module towards the Power Module to lock it.

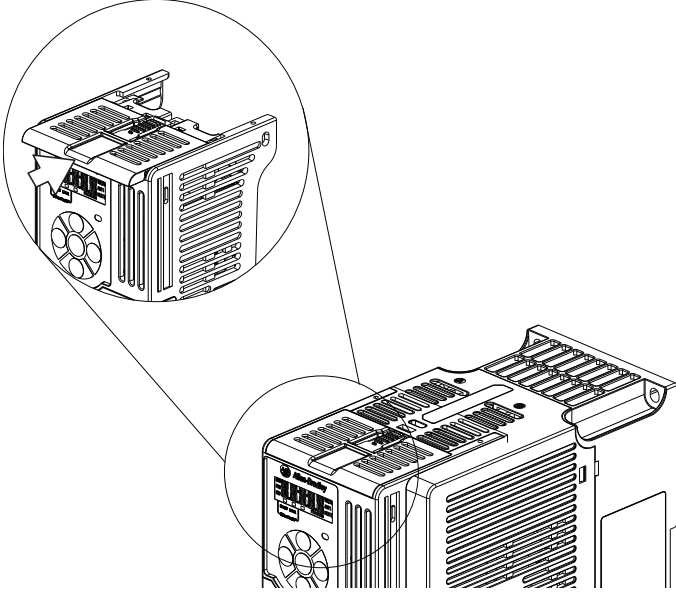

- 3. Insert the catch at the top of the frame cover into the Power Module, then swing the frame cover to snap the side catches onto the Power Module (Frames B...E only).

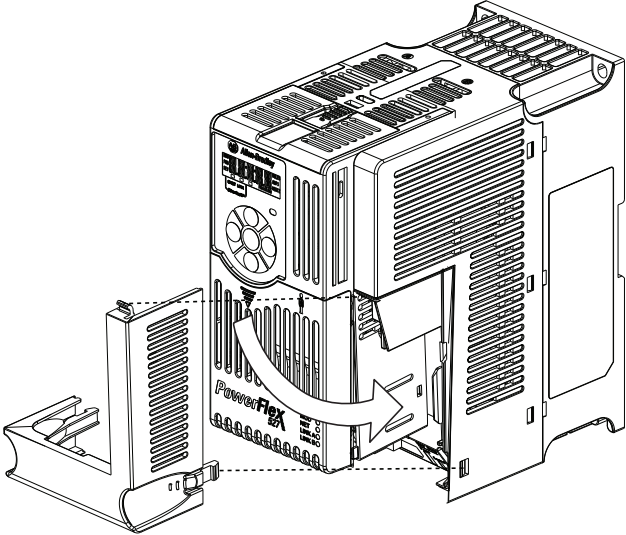

Control Module Cover

To access the control terminals, the front cover must be removed. To remove:

1. Press and hold down the arrow on the front of the cover.
2. Slide the front cover down to remove from the Control Module.

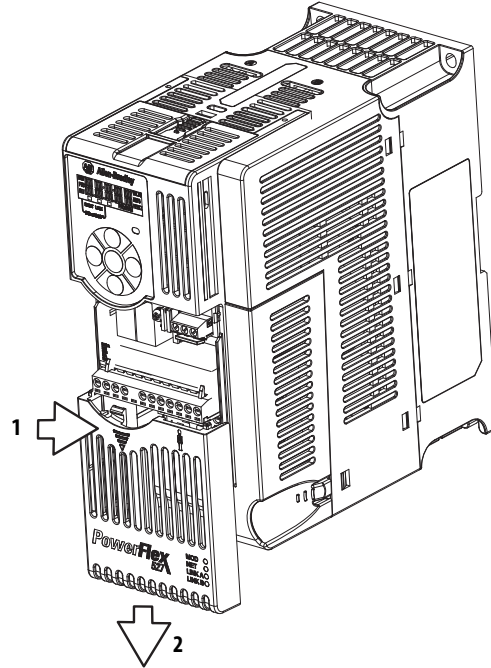

Re-attach the front cover when wiring is complete.

Power Module Terminal Guard

To access the power terminals, the terminal guard must be removed. To remove:

1. Press and hold down the catch on both sides of the frame cover, then pull out and swing upwards to remove (Frames B...E only).

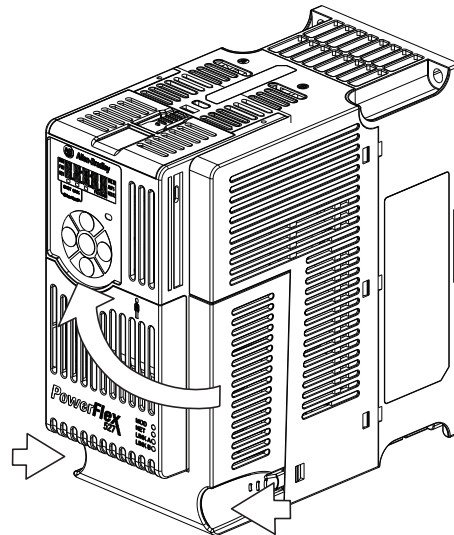

2. Press and hold down the locking tab on the terminal guard.
3. Slide the terminal guard down to remove from the Power Module.

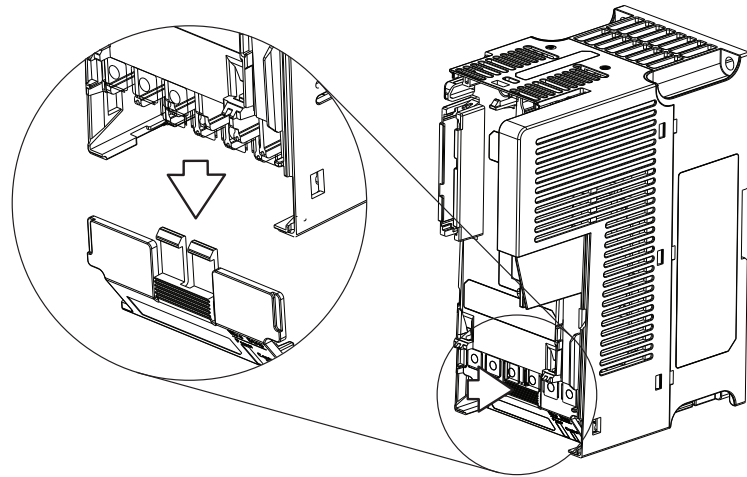

Re-attach the terminal guard when wiring is complete.

To access the power terminals for Frame A, you need to separate the Power and Control Modules. See [Separating the Power and Control Module on page 23](#) for instructions.

Power Wiring

For general wiring and grounding practices, see Wiring and Grounding Guide, (PWM) AC Drives, publication [DRIVES-IN001](#).



ATTENTION: National Codes and standards (NEC, VDE, BSI, etc.) and local codes outline provisions for safely installing electrical equipment. Installation must comply with specifications regarding wire types, conductor sizes, branch circuit protection and disconnect devices. Failure to do so may result in personal injury and/or equipment damage.

ATTENTION: To avoid a possible shock hazard caused by induced voltages, unused wires in the conduit must be grounded at both ends. For the same reason, if a drive sharing a conduit is being serviced or installed, all drives using this conduit should be disabled. This will help minimize the possible shock hazard from "cross coupled" power leads.

Motor Cable Types Acceptable for 100...600 Volt Installations

A variety of cable types are acceptable for drive installations. For many installations, unshielded cable is adequate, provided it can be separated from sensitive circuits. As an approximate guide, allow a spacing of 0.3 m (1 ft) for every 10 m (32.8 ft) of length. In all cases, long parallel runs must be avoided. Do not use cable with an insulation thickness less than 15 mils (0.4 mm/0.015 in.). Do not route more than three sets of motor leads in a single conduit to minimize

“cross talk”. If more than three drive/motor connections per conduit are required, shielded cable must be used.

UL installations above 50 °C ambient must use 600V, 90 °C wire.

UL installations in 50 °C ambient must use 600V, 75 °C or 90 °C wire.

UL installations in 40 °C ambient should use 600V, 75 °C or 90 °C wire.

Use copper wire only. Wire gauge requirements and recommendations are based on 75 °C. Do not reduce wire gauge when using higher temperature wire.



ATTENTION: The distance between the drive and motor must not exceed the maximum cable length stated in the Motor Cable Length Restrictions Tables in “Wiring and Grounding Guide, (PWM) AC Drives,” publication [DRIVES-IN001](#).

Unshielded

THHN, THWN or similar wire is acceptable for drive installation in dry environments provided adequate free air space and/or conduit fill rate limits are provided. Any wire chosen must have a minimum insulation thickness of 15 mils and should not have large variations in insulation concentricity.



ATTENTION: Do not use THHN or similarly coated wire in wet areas.

Shielded/Armored Cable

Shielded cable contains all of the general benefits of multi-conductor cable with the added benefit of a copper braided shield that can contain much of the noise generated by a typical AC Drive. Strong consideration for shielded cable should be given in installations with sensitive equipment such as weigh scales, capacitive proximity switches and other devices that may be affected by electrical noise in the distribution system. Applications with large numbers of drives in a similar location, imposed EMC regulations or a high degree of communications / networking are also good candidates for shielded cable.

Shielded cable may also help reduce shaft voltage and induced bearing currents for some applications. In addition, the increased impedance of shielded cable may help extend the distance that the motor can be located from the drive without the addition of motor protective devices such as terminator networks. Refer to Reflected Wave in “Wiring and Grounding Guide, (PWM) AC Drives,” publication [DRIVES-IN001](#).

Consideration should be given to all of the general specifications dictated by the environment of the installation, including temperature, flexibility, moisture characteristics and chemical resistance. In addition, a braided shield should be included and be specified by the cable manufacturer as having coverage of at least 75%. An additional foil shield can greatly improve noise containment.

A good example of recommended cable is Belden® 295xx (xx determines gauge). This cable has four (4) XLPE insulated conductors with a 100% coverage foil and

an 85% coverage copper braided shield (with drain wire) surrounded by a PVC jacket.

Other types of shielded cable are available, but the selection of these types may limit the allowable cable length. Particularly, some of the newer cables twist 4 conductors of THHN wire and wrap them tightly with a foil shield. This construction can greatly increase the cable charging current required and reduce the overall drive performance. Unless specified in the individual distance tables as tested with the drive, these cables are not recommended and their performance against the lead length limits supplied is not known.

Recommended Shielded Wire

Location	Rating/Type	Description
Standard (Option 1)	600V, 90 °C (194 °F) XHHW2/RHW-2 Anixter B209500-B209507, Belden 29501-29507, or equivalent	<ul style="list-style-type: none"> Four tinned copper conductors with XLPE insulation. Copper braid/aluminum foil combination shield and tinned copper drain wire. PVC jacket.
Standard (Option 2)	Tray rated 600V, 90 °C (194 °F) RHH/RHW-2 Anixter OLF-7xxxx or equivalent	<ul style="list-style-type: none"> Three tinned copper conductors with XLPE insulation. 5 mil single helical copper tape (25% overlap min.) with three bare copper grounds in contact with shield. PVC jacket.
Class I & II; Division I & II	Tray rated 600V, 90 °C (194 °F) RHH/RHW-2 Anixter 7V-7xxx-3G or equivalent	<ul style="list-style-type: none"> Three bare copper conductors with XLPE insulation and impervious corrugated continuously welded aluminum armor. Black sunlight resistant PVC jacket overall. Three copper grounds on #10 AWG and smaller.

Reflected Wave Protection

The drive should be installed as close to the motor as possible. Installations with long motor cables may require the addition of external devices to limit voltage reflections at the motor (reflected wave phenomena). Refer to Reflected Wave in “Wiring and Grounding Guide, (PWM) AC Drives,” publication [DRIVES-IN001](#).

The reflected wave data applies to all carrier frequencies 2...8 kHz.

For 240V ratings and lower, reflected wave effects do not need to be considered.

Output Disconnect

The drive is intended to be commanded by motion commands that will start and stop the motor. A device that routinely disconnects then reapplies output power to the motor for the purpose of starting and stopping the motor should not be used. If it is necessary to disconnect power to the motor with the drive outputting power, use Logix Designer to disable the drive (Aux Fault or Coast to Stop).

Power Terminal Block

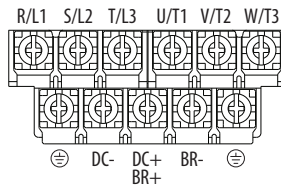

Power Terminal Block

Frame A, B, C & D

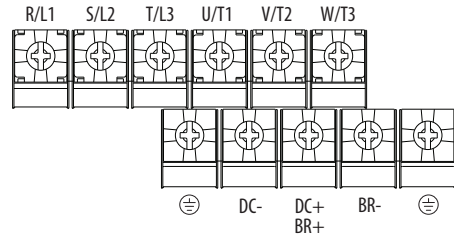

Frame E

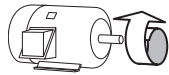

Terminal	Description
R/L1, S/L2	1-Phase Input Line Voltage Connection
R/L1, S/L2, T/L3	3-Phase Input Line Voltage Connection
U/T1, V/T2, W/T3	Motor Phase Connection =  Switch any two motor leads to change forward direction.
DC+, DC-	DC Bus Connection
BR+, BR-	Dynamic Brake Resistor Connection
	Safety Ground - PE

IMPORTANT Terminal screws may become loose during shipment. Ensure that all terminal screws are tightened to the recommended torque before applying power to the drive.

Power Terminal Block Wire Specifications

Frame	Maximum Wire Size ⁽¹⁾	Minimum Wire Size ⁽¹⁾	Torque
A	5.3 mm ² (10 AWG)	0.8 mm ² (18 AWG)	1.76...2.16 Nm (15.6...19.1 lb-in.)
B	8.4 mm ² (8 AWG)	2.1 mm ² (14 AWG)	1.76...2.16 Nm (15.6...19.1 lb-in.)
C	8.4 mm ² (8 AWG)	2.1 mm ² (14 AWG)	1.76...2.16 Nm (15.6...19.1 lb-in.)
D	13.3 mm ² (6 AWG)	5.3 mm ² (10 AWG)	1.76...2.16 Nm (15.6...19.1 lb-in.)
E	26.7 mm ² (3 AWG)	8.4 mm ² (8 AWG)	3.09...3.77 Nm (27.3...33.4 lb-in.)

(1) Maximum/minimum sizes that the terminal block will accept – these are not recommendations.

I/O Wiring

Motor Start/Stop Precautions



ATTENTION: A contactor or other device that routinely disconnects and reapplies the AC line to the drive to start and stop the motor can cause drive hardware damage. The drive is designed to use control input signals that will start and stop the motor. If used, the input device must not exceed one operation per minute or drive damage can occur.

Important points to remember about I/O wiring:

- Always use copper wire.
- Wire with an insulation rating of 600V or greater is recommended.
- Control and signal wires should be separated from power wires by at least 0.3 m (1 ft).

IMPORTANT I/O terminals labeled “Common” are not referenced to the safety ground (PE) terminal and are designed to greatly reduce common mode interference.



ATTENTION: Driving the 4-20 mA analog input from a voltage source could cause component damage. Verify proper configuration prior to applying input signals.

Signal and Control Wire Types

Recommendations are for 50 °C ambient temperature.
75 °C wire must be used for 60 °C ambient temperature.
90 °C wire must be used for 70 °C ambient temperature.

Recommended Signal Wire

Signal Type/ Where Used	Belden Wire Type(s) ⁽¹⁾ (or equivalent)	Description	Min. Insulation Rating
Analog I/O	8760/9460	0.750 mm ² (18 AWG), twisted pair, 100% shield with drain ⁽²⁾	300V, 60 °C (140 °F)
Remote Pot	8770	0.750 mm ² (18 AWG), 3 conductor, shielded	
Encoder	9728/9730	0.196 mm ² (24 AWG), individually shielded pairs	

(1) Stranded or solid wire.

(2) If the wires are short and contained within a cabinet which has no sensitive circuits, the use of shielded wire may not be necessary, but is always recommended.

Recommended Control Wire for Digital I/O

Type	Wire Type(s)	Description	Min. Insulation Rating
Unshielded	Per US NEC or applicable national or local code	–	300V, 60 °C (140 °F)
Shielded	Multi-conductor shielded cable such as Belden 8770 (or equivalent)	0.750 mm ² (18 AWG), 3 conductor, shielded.	

Maximum Control Wire Recommendations

Do not exceed control wiring length of 30 m (100 ft). Control signal cable length is highly dependent on electrical environment and installation practices. To improve noise immunity, the I/O terminal block Common may be connected to ground terminal/protective earth.

Control I/O Terminal Block

Control I/O Terminal Block Wire Specifications

Frame	Maximum Wire Size ⁽¹⁾	Minimum Wire Size ⁽¹⁾	Torque
A...E	1.3 mm ² (16 AWG)	0.13 mm ² (26 AWG)	0.71...0.86 Nm (6.2...7.6 lb-in.)

(1) Maximum/minimum sizes that the terminal block will accept – these are not recommendations.

PowerFlex 527 Control I/O Removable Terminal Block

PowerFlex 527 Control I/O Wiring Block Diagram

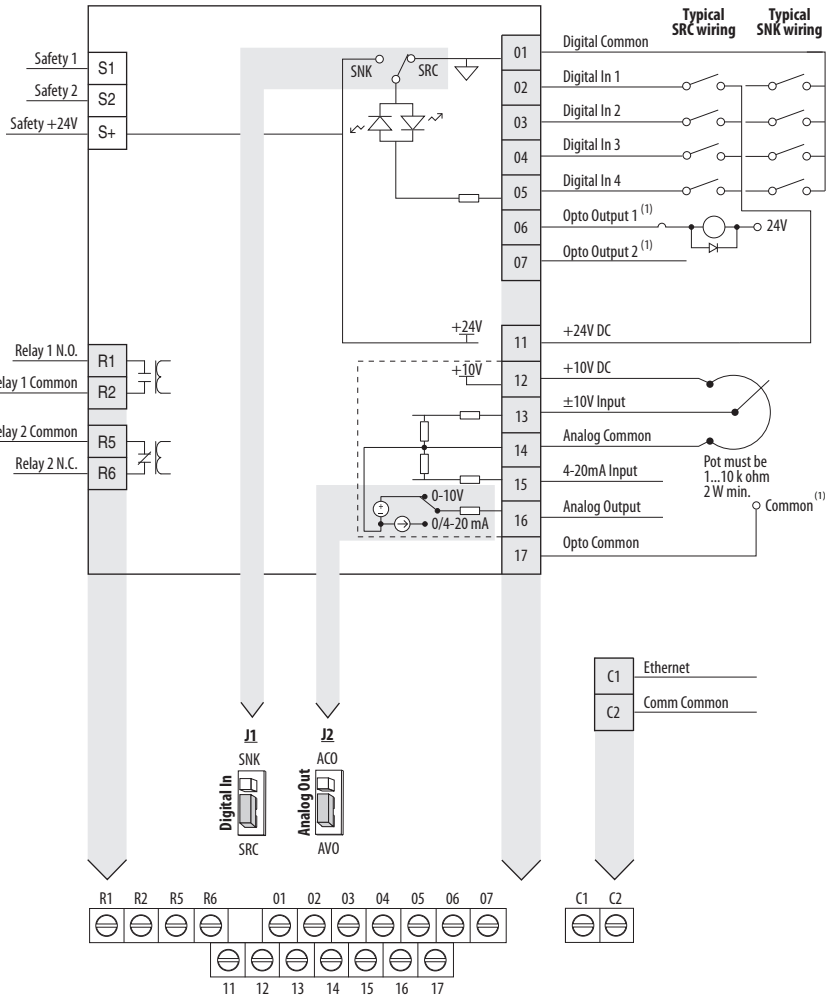

(1) When using an opto output with an inductive load such as a relay, install a recovery diode parallel to the relay as shown, to prevent damage to the output.

Control I/O Terminal Designations

No.	Signal	Description
R1	Relay 1 N.O.	These are the Normally Open (NO), Common, and Normally Closed (NC) contacts for the programmable relay output.
R2	Relay 1 Common	
R5	Relay 2 Common	
R6	Relay 2 N.C.	Resistive: 1.0A @ 30V DC/ 0.2A @ 125V AC/ 0.1A @ 230V AC Inductive: 0.5A @ 30V DC/0.1A @ 125V AC/ 0.1A @ 230V AC Rated minimum current is 5 mA or less @ 24V DC.
01	Digital Common	The return for digital I/O. It is electrically isolated (along with the digital I/O) from the rest of the drive, except for the communications port.

Control I/O Terminal Designations

No.	Signal	Description
02	Digital In 1	Configurable to Home, Registration 1, Drive Enable, Positive Overtravel, and Negative Overtravel.
03	Digital In 2	Configurable to Registration 2, Drive Enable, Positive Overtravel, and Negative Overtravel.
04	Digital In 3	Configurable to Drive Enable, Positive Overtravel, and Negative Overtravel.
05	Digital In 4	Configurable to Drive Enable, Positive Overtravel, and Negative Overtravel.
06	Opto Output 1	Programmable digital output.
07	Opto Output 2	
C1	Ethernet	This terminal is tied to the Ethernet port shield. Tie this terminal to a clean ground in order to improve noise immunity when using external communication peripherals.
C2	Comm Common	This is the signal common for the communication signals.
S1	Safety 1	Safety input 1
S2	Safety 2	Safety input 2
S+	Safety +24V	+24V supply for safety circuit. This is internally tied to the +24V DC source (Pin-11).
11	+24V DC	+24V DC (+/-10%) supply for digital inputs. It is rated to supply at least 100 mA and will use Digital Common as the return. It will also be short-circuit protected (not damaged if tied to a Common or GND) and will not be damaged if connected to the +24V DC source of a different drive.
12	+10V DC	+10V DC (-0% / +6%) supply for potentiometer or 0-10V input. It is rated to supply at least 15 mA and will use Analog Common as the return. It will also be short-circuit protected (not damaged if tied to a Common or GND) and will not be damaged if connected to the +10V DC source of a different drive.
13	±10V In	+/- 10V bipolar analog input optically isolated from the drive to avoid ground loops. This input has approximately 100K Ω input impedance. If a remote potentiometer is used with this input the maximum pot impedance is 10K Ω and the minimum impedance and the maximum is still 10K Ω . The A/D resolution will be 10-bit or better. The drive will not be damaged if up to +/- 27V DC or Voltage surge up to 1 kV is applied to this port. The input bandwidth shall be about 100 Hz.
14	Analog Common	This is the return for the analog I/O. It is electrically isolated (along with the analog I/O) from the rest of the drive.
15	4-20mA In	4-20 mA analog input optically isolated from the drive to allow daisy chain configurations and to avoid ground loops. The input impedance for the 4-20 mA analog input is approximately 250 Ω . The A/D resolution will be 10-bit or better.
16	Analog Output	Configurable to a 0-20 mA or 0-10V analog output signal. Set the Analog Out jumper (J2) as shown, then set the ACO/AVO attribute. See Setting the ACO/AVO Attribute on page 164 for instructions.
17	Opto Common	The emitters of the Optocoupler Outputs (1 and 2) are tied together at Optocoupler Common. They are therefore electrically isolated from the rest of the drive.

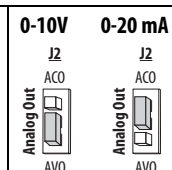
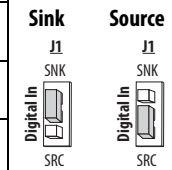

Tag Attributes in Logix Designer for Inputs and Outputs

No.	Signal	Tag Attribute
Analog Input		
13	±10V In	<axis tag>.AnalogInput1
15	4-20mA In	<axis tag>.AnalogInput2
Analog Output		
16	Analog Output	<axis tag>.AnalogOutput1
Digital Input		
02	Digital In 1	<axis tag>.DigitalInput0
03	Digital In 2	<axis tag>.DigitalInput1

Tag Attributes in Logix Designer for Inputs and Outputs

No.	Signal	Tag Attribute
04	Digital In 3	<axis tag>.DigitalInput2
05	Digital In 4	<axis tag>.DigitalInput3
Digital Output		
06	Opto Output 1	<axis tag>.DigitalOutput0
07	Opto Output 2	<axis tag>.DigitalOutput1
R1	Relay 1 N.O.	<axis tag>.DigitalOutput2
R6	Relay 2 N.C.	<axis tag>.DigitalOutput3

CE Conformity

Compliance with the Low Voltage Directive and Electromagnetic Compatibility Directive has been demonstrated using harmonized European Norm (EN) standards published in the Official Journal of the European Communities. PowerFlex 520-series drives comply with the EN standards listed below when installed according to the installation instructions in this manual.

For product certifications currently available from Rockwell Automation, go to <http://www.rockwellautomation.com/products/certification/>.

For all declarations of conformity (DoC) currently available from Rockwell Automation, go to <http://www.rockwellautomation.com/rockwellautomation/certification/overview.page>.

Low Voltage Directive (2006/95/EC)

- EN 61800-5-1 Adjustable speed electrical power drive systems – Part 5-1: Safety requirements – Electrical, thermal and energy.

Pollution Degree Ratings According to EN 61800-5-1

Pollution Degree	Description
1	No pollution or only dry, non-conductive pollution occurs. The pollution has no influence.
2	Normally, only non-conductive pollution occurs. Occasionally, however, a temporary conductivity caused by condensation is to be expected, when the drive is out of operation.

EMC Directive (2004/108/EC)

- EN 61800-3:2004+A1:2012 – Adjustable speed electrical power drive systems - Part 3: EMC requirements and specific test methods

Machinery Directive (2006/42/EC)

- EN ISO 13849-1:2008+AC:2009 – Safety of machinery – Safety related parts of control systems -Part 1: General principles for design.
- EN 61800-5-2:2007 – Adjustable speed electrical power drive systems - Part 5-2: Safety requirement – Functional.

- EN 62061:2005+A1:2013 – Safety of machinery – Functional safety of safety-related electrical, electronic and programmable electronic control systems.
- EN 60204-1:2006+A1:2009 – Safety of machinery – Electrical equipment of machines - Part 1: General requirements.
- IEC 61508 Part 1-7:2010 Functional safety of electrical/electronic/programmable electronic safety-related systems – Parts 1-7.

General Considerations

- For CE compliance, drives must satisfy installation requirements related to both EN 61800-5-1 and EN 61800-3 provided in this document.
- PowerFlex 520-series drives must be installed in a pollution degree 1 or 2 environment to be compliant with the CE LV Directive. See [Pollution Degree Ratings According to EN 61800-5-1 on page 34](#) for descriptions of each pollution degree rating.
- PowerFlex 520-series drives comply with the EMC requirements of EN 61800-3 when installed according to good EMC practices and the instructions provided in this document. However, many factors can influence the EMC compliance of an entire machine or installation, and compliance of the drive itself does not ensure compliance of all applications.
- PowerFlex 520-series drives are not intended to be used on public low-voltage networks which supply domestic premises. Without additional mitigation, radio frequency interference is expected if used on such a network. The installer is responsible for taking measures such as a supplementary line filter and enclosure (see [Connections and Grounding on page 37](#)) to prevent interference, in addition to the installation requirements of this document.



ATTENTION: NEMA/UL Open Type drives must either be installed in a supplementary enclosure or equipped with a “NEMA Type 1 Kit” to be CE compliant with respect to protection against electrical shock.

- PowerFlex 520-series drives generate harmonic current emissions on the AC supply system. When operated on a public low-voltage network it is the responsibility of the installer or user to ensure that applicable requirements of the distribution network operator have been met. Consultation with the network operator and Rockwell Automation may be necessary.
- If the optional NEMA 1 kit is not installed, the drive must be installed in an enclosure with side openings less than 12.5 mm (0.5 in.) and top openings less than 1.0 mm (0.04 in.) to maintain compliance with the LV Directive.
- The motor cable should be kept as short as possible in order to avoid electromagnetic emission as well as capacitive currents.
- Use of line filters in ungrounded systems is not recommended.

- In CE installations, input power must be a Balanced Wye with Center Ground configuration for EMC compliance.
- If the DC Bus terminals or the Dynamic Brake terminals are used, the drive must be installed in an enclosure and fuses must be used for input protection. The ventilated enclosure needs to be IP 20 rating or higher and at least 1.5x size larger than the drive.

Installation Requirements Related to EN 61800-5-1 and the Low Voltage Directive

- 600V PowerFlex 520-series drives can only be used on a “center grounded” supply system for altitudes up to and including 2000 m (6562 ft).
- When used at altitudes above 2000 m (6562 ft) up to a maximum of 4800 m (15,748 ft), PowerFlex 520-series drives of voltage classes up to 480V may not be powered from a “corner-earthed” supply system in order to maintain compliance with the CE LV Directive. See [Derating Guidelines for High Altitude on page 14](#).
- PowerFlex 520-series drives produce leakage current in the protective earthing conductor which exceeds 3.5 mA AC and/or 10 mA DC. The minimum size of the protective earthing (grounding) conductor used in the application must comply with local safety regulations for high protective earthing conductor current equipment.



ATTENTION: PowerFlex 520-series drives produce DC current in the protective earthing conductor which may reduce the ability of RCD's (residual current-operated protective devices) or RCM's (residual current-operated monitoring devices) of type A or AC to provide protection for other equipment in the installation. Where an RCD or RCM is used for protection in case of direct or indirect contact, only an RCD or RCM of Type B is allowed on the supply side of this product.

Installation Requirements Related to EN 61800-3 and the EMC Directive

- The drive must be earthed (grounded) as described in [Connections and Grounding on page 37](#). See [General Grounding Requirements on page 16](#) for additional grounding recommendations.
- Output power wiring to the motor must employ cables with a braided shield providing 75% or greater coverage, or the cables must be housed in metal conduit, or equivalent shield must be provided. Continuous shielding must be provided from the drive enclosure to the motor enclosure. Both ends of the motor cable shield (or conduit) must terminate with a low-impedance connection to earth.
Drive Frames A...E: At the drive end of the motor, either
 - a. The cable shield must be clamped to a properly installed “EMC Plate” for the drive. Kit number 25-EMC1-Fx.
or
 - b. The cable shield or conduit must terminate in a shielded connector installed in an EMC plate, conduit box, or similar.

- At the motor end, the motor cable shield or conduit must terminate in a shielded connector which must be properly installed in an earthed motor wiring box attached to the motor. The motor wiring box cover must be installed and earthed.
- All control (I/O) and signal wiring to the drive must use cable with a braided shield providing 75% or greater coverage, or the cables must be housed in metal conduit, or equivalent shielding must be provided. When shielded cable is used, the cable shield should be terminated with a low impedance connection to earth at only one end of the cable, preferably the end where the receiver is located. When the cable shield is terminated at the drive end, it may be terminated either by using a shielded connector in conjunction with a conduit plate or conduit box, or the shield may be clamped to an “EMC plate.”
- Motor cabling must be separated from control and signal wiring wherever possible.
- Maximum motor cable length must not exceed the maximum length indicated in [PowerFlex 527 RF Emission Compliance and Installation Requirements on page 37](#) for compliance with radio frequency emission limits for the specific standard and installation environment.

Connections and Grounding

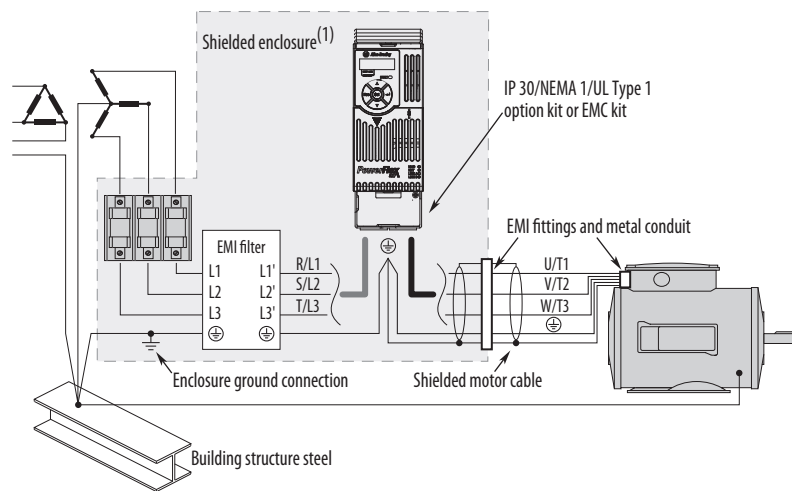

(1) Some installations require a shielded enclosure. Keep wire length as short as possible between the enclosure entry point and the EMI filter.

PowerFlex 527 RF Emission Compliance and Installation Requirements

Filter Type	Standard/Limits		
	EN61800-3 Category C1 EN61000-6-3 CISPR11 Group 1 Class B	EN61800-3 Category C2 EN61000-6-4 CISPR11 Group 1 Class A (Input power ≤ 20 kVA)	EN61800-3 Category C3 (I ≤ 100 A) CISPR11 Group 1 Class A (Input power > 20 kVA)
Internal	–	10 m (33 ft)	20 m (66 ft)
External ⁽¹⁾	30 m (16 ft)	100 m (328 ft)	100 m (328 ft)

(1) See [Appendix B](#) for more information on optional external filters.

Additional Installation Requirements

This section provides information on additional requirements for Class C1 and C2 installation, such as enclosures and EMC cores.

IMPORTANT EMC cores are included with:

- drives that have an internal EMC filter (25x-xxxxN114)
- external EMC filter accessory kit (25-RFxxx)

IMPORTANT An enclosure, shielded input cable, and EMC cores are not required to meet class C3 requirements.

Additional Installation Requirements

Frame Size	Class C1			Class C2		
	Enclosure	Conduit or Shielded Cable @ Input	EMC Cores Required (Included with product)	Enclosure	Conduit or Shielded Cable @ Input	EMC Cores Required (Included with product)
100...120V AC (-15%, +10%) – 1-Phase Input with External EMC Filter, 0...120V 1-Phase Output						
A	No	No	No	No	No	No
B	No	No	No	No	No	No
200...240V AC (-15%, +10%) – 1-Phase Input with External EMC Filter, 0...230V 3-Phase Output						
A	Yes	Yes	No	No	No	Input/Output
B	Yes	Yes	Output only	No	No	Input/Output
200...240V AC (-15%, +10%) – 1-Phase Input with Internal EMC Filter, 0...230V 3-Phase Output⁽¹⁾						
A	*	*	*	Yes	No	No
B	*	*	*	Yes	No	No
200...240V AC (-15%, +10%) – 3-Phase Input with External EMC Filter, 0...230V 3-Phase Output						
A	Yes	Yes	Output only	No	No	Input/Output
B	Yes	Yes	Output only	No	No	Input/Output
C	Yes	Yes	Output only	No	No	Input/Output
D	Yes	Yes	No	No	No	Input only
E	Yes	Yes	Output only	No	No	Input only
380...480V AC (-15%, +10%) – 3-Phase Input with External EMC Filter, 0...460V 3-Phase Output						
A	Yes	Yes	No	No	No	Input/Output
B	Yes	Yes	No	No	No	Input/Output
C	Yes	Yes	No	No	No	Input only
D	Yes	Yes	Output only	No	No	Input/Output
E	Yes	Yes	No	Yes	No	Input/Output
380...480V AC (-15%, +10%) – 3-Phase Input with Internal EMC Filter, 0...460V 3-Phase Output⁽¹⁾						
A	*	*	*	No	No	Input/Output
B	*	*	*	No	No	Input/Output
C	*	*	*	No	No	Input/Output
D	*	*	*	No	No	Input/Output
E	*	*	*	No	No	Input/Output
525...600V AC (-15%, +10%) – 3-Phase Input with External EMC Filter, 0...575V 3-Phase Output						
A	Yes	Yes	No	No	No	Input/Output
B	Yes	Yes	No	No	No	Input/Output
C	Yes	Yes	No	No	No	Input/Output
D	Yes	Yes	No	No	No	Input/Output
E	Yes	Yes	No	Yes	No	No

(1) An (*) indicates that EMC requirements are not met.

Recommended Placement of EMC Cores with Optional EMC Plate

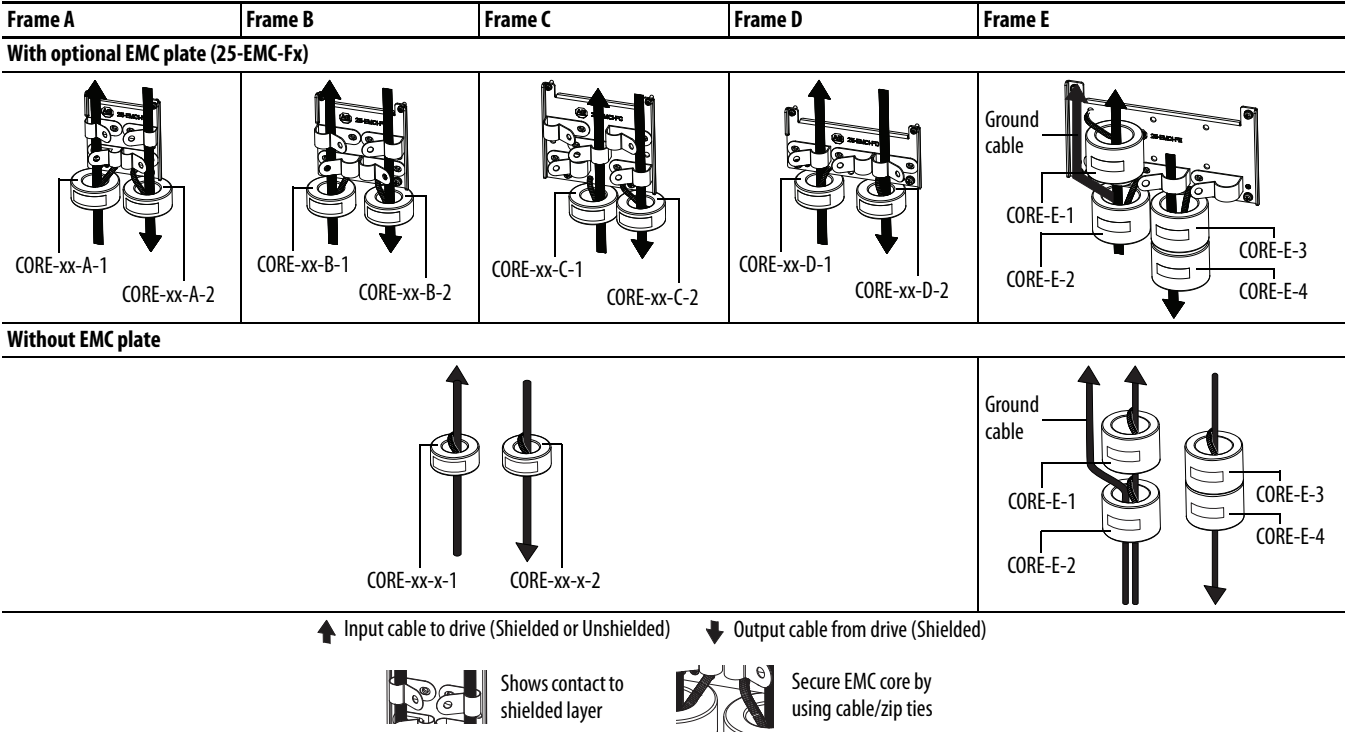

IMPORTANT

- The ground cable/shield for both input and output must pass through the EMC core(s), except for the following:
- Frame E drives with internal filters where the grounded input cable must not pass through EMC CORE-E-1.
 - 600V drives with external filters where the grounded output cable must not pass through the EMC core(s).

Recommended Placement of EMC Cores Relative to External Filter

All Frame sizes

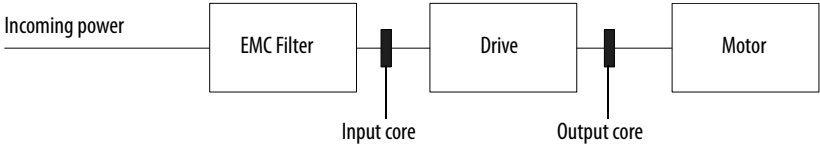

Notes:

Start Up

This chapter describes how to start up the PowerFlex 527 drive.

For information on...	See page...
Prepare for Drive Start-Up	41
Understanding the PowerFlex 527 Display and Indicators	42
Drive Programming Tools	47
Language Support	47
Using the Ethernet Port	48

IMPORTANT Read the section [General Precautions on page 9](#) before proceeding.



ATTENTION: Power must be applied to the drive to perform the following start-up procedures. Some of the voltages present are at incoming line potential. To avoid electric shock hazard or damage to equipment, only qualified service personnel should perform the following procedure. Thoroughly read and understand the procedure before beginning. If an event does not occur while performing this procedure, **Do Not Proceed. Remove All Power** including user supplied control voltages. User supplied voltages may exist even when main AC power is not applied to the drive. Correct the malfunction before continuing.

Prepare for Drive Start-Up

Before starting up the drive, it is recommended to perform the startup tasks described below to ensure a smooth startup and drive operation. Ensure that the drive is not powered (check that DC Bus voltage is less than 50V DC) before proceeding with the startup task list.

Drive Startup Task List

1. Disconnect and lock out power to the machine.
2. Verify that AC line power at the disconnect device is within the rated value of the drive.
3. If replacing a drive, verify the current drive's catalog number. Verify all options installed on the drive.
4. Verify that any digital control power is 24 volts.
5. Inspect grounding, wiring, connections, and environmental compatibility.
6. Verify that the Sink (SNK)/Source (SRC) jumper is set to match your control wiring scheme. See the [PowerFlex 527 Control I/O Wiring Block Diagram on page 32](#) for location.

7. Wire I/O as required for the application.
8. Wire the power input and output terminals.
9. Confirm that all inputs are connected to the correct terminals and are secure.
10. Collect and record motor nameplate and encoder or feedback device information. Verify motor connections.
 - Is the motor uncoupled?
 - What direction will the motor need to turn for the application?
11. Verify the input voltage to the drive. Verify if the drive is on a grounded system. Ensure the MOV jumpers are in the correct position. See [AC Supply Source Considerations on page 15](#) for more information.
12. Apply AC power to the drive.
 - You need to establish a connection with a Logix controller and verify that the drive is enabled using a Logix motion instruction (for example MSO command) and no “START INHIBIT” condition exists. See [Configuring the PowerFlex 527 Drive with Integrated Motion on page 49](#) for instructions.
 - Verify the drive is receiving start and stop commands correctly.
 - Verify input currents are balanced.
 - Verify motor currents are balanced.

Start, Stop, Direction, and Speed Control

Start, Stop, Direction, and Speed Control are done using Logix motion instructions (for example, Motion Drive Start (MDS)). See the Logix5000 Motion Controllers Instructions Reference Manual, publication [MOTION-RM002](#) for more information.

Understanding the PowerFlex 527 Display and Indicators

The PowerFlex 527 drive has four status indicators, a fault indicator, an LCD display, and a membrane keypad for navigation. The display is used to view information such as motor information, axis states, faults, and set the network configuration. The indicators are used to monitor the module and network status, and troubleshoot faults.

PowerFlex 527 Drive LCD Display and Status Indicators

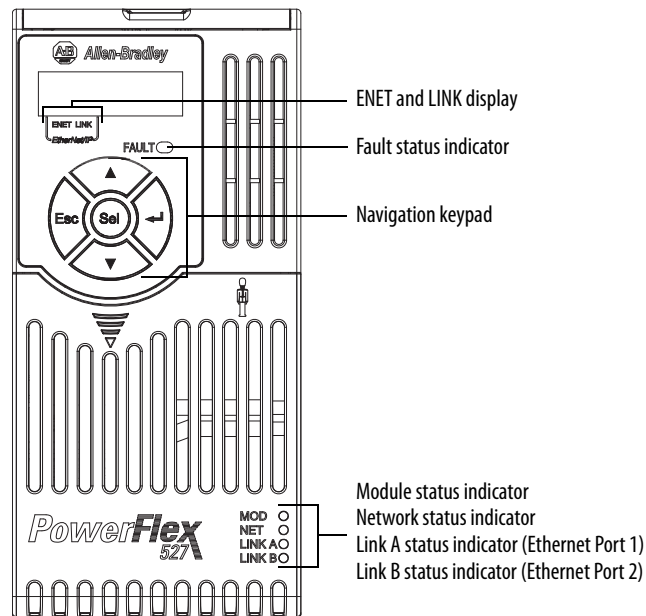

Display	Display State	Description
ENET	Off	Drive is not connected to the network.
	Steady	Drive is connected to the network.
LINK	Off	Drive has not established a controller connection.
	Steady	Drive is connected to the network and a controller connection has been established.

LED	LED State	Description
FAULT	Steady	Indicates drive is faulted. See Fault Codes on page 120 for more information.

Key	Name	Description
	Up Arrow Down Arrow	Pressing either arrow moves the selection to the next (or previous) item. When changing values, pressing the Up arrow increments the highlighted value. Values rollover after reaching the end of the list.
	Escape	Press to go back. Pressing enough times results in the HOME screen.
	Select	Press to select a menu item.
	Enter	Press to confirm the selection and go to sub-menu items.

LED	LED State	Description
MOD	Steady Green	Drive is operational and no fault exists.
NET	Steady Green	Drive is online and has connections in the established state.
LINK A (Ethernet Port 1) LINK B (Ethernet Port 2)	Steady Green	Drive is connected to the network but not transmitting data.

For detailed descriptions of the Fault, MOD, NET, and LINK A/B status indicators, see [PowerFlex 527 Drive Status Indicators on page 124](#).

Startup Sequence



On power-up, the drive will initialize and status information will scroll across the LCD display.



After initialization, the Device/Axis state will be shown on the LCD display. In this example, the current state is STANDBY.

Device and Axis States

The following tables lists all the possible states and their descriptions for Device and Axis.

Device State	Description
STANDBY	The drive is waiting to receive configuration information from the controller.
CONNECTING	The drive is trying to establish communication with the EtherNet/IP controller.
CONFIGURING	The drive is receiving configuration information from the controller.
SYNCING	The drive is waiting for a successful Group Sync service.
CONN_TIMEOUT	The drive is trying to establish communication with the EtherNet/IP controller but the connection has timed out.
DUPLICATE_IP	The drive has detected another device on the network with the same IP address.
FWUPDATE	The drive is updating the firmware.



Axis State	Description
INITIALIZING	The drive is initializing the motion connection.
PRECHARGE	The drive is ready for mains input power.
STOPPED	The drive is in the Stopped state and awaiting a motion command.
STARTING	The drive has received a motion command and is transitioning to the Running state from the Stopped state.
RUNNING	The drive is enabled and/or running.
TESTING	The drive is actively executing a test procedure, for example, a hookup test.
STOPPING	The drive is decelerating to a stop as the result of a disable.
ABORTING	The drive is decelerating to a stop as the result of a fault or an abort request.
MAJOR FAULTED	The drive is faulted due to an existing or past fault condition.
START INHIBITED	The drive has an active condition that inhibits it from being enabled.
SHUTDOWN	The drive has been shut down.

If a boot fault occurs during initialization, a fault number shows up on the screen with the format, “BFxxx”, where “BF” stands for boot fault and “xxx” refers to the fault code. In this example, fault BF003 is shown.



For a list of other types of possible faults, see [Fault Codes on page 120](#).

Information Display

From the axis state screen, press Select  or the Down  arrow to access the following information menu:

Screen Option	Description	Example Display ⁽¹⁾
Version Info	Provides information on the hardware and software versions.	HW Ver 01.002 FW Ver 01.102
Device Info	Provides information on the drive type, network configuration, and IP address.	PowerFlex 527 Static IP 192.168.1.180 or PowerFlex 527 DHCP 192.168.1.180 ⁽²⁾
Settings	Allows configuration of network settings, changing the display language, and resetting the drive.	See Network Configuration on page 45 for instructions on how to configure the IP address.

(1) The LCD only accommodates up to five characters. Text strings that are more than five characters are scrolled.

(2) If "0.0.0.0" is displayed and DHCP is enabled, it means that the IP address has not been assigned by the DHCP server. Check your network settings.

Network Configuration

Through the settings option, you can configure the drive IP address. There are two methods for configuring the drive IP address:

- **Static IP** – Use Static IP when you want to manually configure the IP address, subnet mask, and gateway addresses.
- **DHCP (Dynamic Host Configuration Protocol)** – Use DHCP when you want convenience and ease-of-use compared to Static IP. The IP address, subnet mask, and gateway addresses will be assigned automatically by the DHCP server.













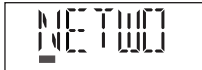





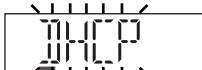

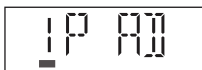

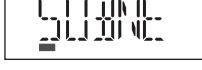

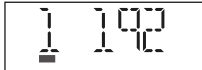

IMPORTANT Regardless of the method used to set the adapter IP address, each node on the EtherNet/IP network must have a unique IP address. To change an IP address, you must set the new value and then power cycle the drive.

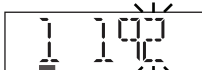
You can also use the Reset function, however all safety connections will have to be disabled before this option is available.

Settings Options

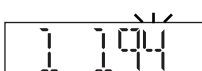
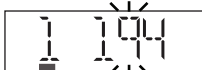
Settings Menu Selections	Sub Menu Selections	Attributes	Default	Description
Network	Static IP	IP address	192.168.1.180	Indicates current IP address.
		Subnet mask	255.255.255.0	Indicates current subnet mask.
		Gateway	192.168.1.1	Indicates current gateway.
	DHCP	IP address	Automatically assigned by the DHCP server.	Indicates current IP address.
		Subnet mask		Indicates current subnet mask.
		Gateway		Indicates current gateway.

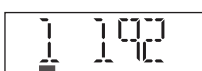
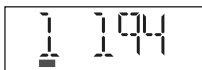
Configuring Network Settings

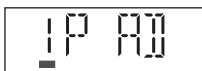
Step	Keys	Example Display
1. On the Device/Axis state screen, press the Down arrow to go to the Settings menu.		
2. Press Enter to display the Network Settings screen.		
3. Press the Up or Down arrow to select either DHCP or Static IP, then press Enter. If you choose DHCP, go to step 4 . If you choose Static IP, go to step 5 .	 or 	 or 
4. Press Enter to confirm DHCP as the network configuration option. Choosing DHCP automatically configures the IP settings for your drive. This completes the network configuration for your drive.		
5. Choosing Static IP enables you to manually configure the IP address, subnet mask, and gateway address for your drive. Press the Up or Down arrow to scroll through the settings.	 or 	  
6. In this example, we will start by configuring the IP address. Select IP address, then press Enter to display the first octet of the IP address.		
7. Press the Up or Down arrow to scroll through the four octets of the IP address.	 or 	
8. Press Sel to edit an octet. The rightmost digit of the octet will flash.		
9. Press the Up or Down arrow to change the digit. Press Sel to edit the digits on the left.	 or  	 
10. Press ESC to cancel a change and exit the edit mode. Or Press Enter to save a change and exit the edit mode.	 or 	 or 
11. Repeat step 7 to step 10 to edit the values of the other octets. After you have finished configuring the IP address. Press ESC to go back to the Static IP menu.		
12. Repeat step 5 to step 11 to configure the subnet mask and gateway address.		
13. Power cycle the drive to store the new IP settings.		
This completes the network configuration for your drive.		

IMPORTANT You must cycle power to make network configuration changes persistent. An asterisk (*) is shown next to the network configuration when viewing the Device Info screen option to signify that a change has been made but has not taken effect.

For example, after changing the network configuration from Static IP to DHCP, when viewing the Device Info screen option, an asterisk (*) appears next to the text "DHCP" on the LCD display.



The change takes effect and the asterisk is removed after the drive is power cycled.

Display configuration changes take effect immediately.

Real-time Information Display

Once the drive is enabled and running and connected to a controller, the following information can be accessed through the LCD screen.

Real-time Information	Description	Example Display
Velocity Feedback	Displays the value of the velocity feedback	VELOCITY FDBK 0.0
Motor Current	Displays the value of the motor current	MOTOR CRNT 0.0
Motor Utilization	Displays the value of the motor utilization	MOTOR UTIL:0.0
Shunt Utilization	Displays the value of the shunt utilization	SHUNT UTIL: 0.0
DC Bus Voltage	Displays the value of the DC Bus voltage	DC BUS VLTG 0.0
Current Command	Displays the value of the torque current	CURRENT CMD 0.0

Drive Programming Tools

Some features in the PowerFlex 527 drive are not supported by older configuration software tools. It is strongly recommended that customers using such tools migrate to Studio 5000 Logix Designer™ (version 24 or greater) with Add-On-Profile (AOP) to enjoy a richer, full-featured configuration experience.

Language Support

Language	Keypad/LCD Display	Logix Designer
English	Y	Y
French	Y	Y
Spanish	Y	Y
Italian	Y	Y
German	Y	Y
Japanese	–	Y
Portuguese	Y	Y
Chinese Simplified	–	Y
Korean	–	Y
Polish ⁽¹⁾	Y	–
Turkish ⁽¹⁾	Y	–
Czech ⁽¹⁾	Y	–

(1) Due to a limitation of the LCD display, some of the characters for Polish, Turkish, and Czech will be modified.

Using the Ethernet Port

The PowerFlex 527 drive has dual embedded Ethernet ports that connect the drive to an EtherNet/IP network. This enables communication with a Logix based control system for drive control using CIP Motion commands. You can also upgrade the drive firmware or upload/download a configuration easily using the Studio 5000 Logix Designer application.

The EtherNet/IP network offers a full suite of control, configuration, and data collection services by layering the Common Industrial Protocol (CIP) over the standard protocols used by the Internet (TCP/IP and UDP). EtherNet/IP uses TCP/IP for general messaging/information exchange services and UDP/IP for I/O messaging services for control applications.

Liner, Star, and Device Level Ring network topologies are supported by the PowerFlex 527 drive. Plus, the application of the CIP Safety protocol enables the simultaneous transmission of safety and standard control data and diagnostics information.

Configuring the PowerFlex 527 Drive with Integrated Motion

This chapter procedures on how to set up Integrated Motion on the EtherNet/IP network control by using a PowerFlex 527 Drive.

For information on...	See page...
Configure the Drive	49
Configure the Logix Designer Application Project	50
Add a PowerFlex 527 Drive	55
Configure the PowerFlex 527 Drive	57
Apply Power to the PowerFlex 527 Drive	80
Test and Tune the Axes – Velocity and Position Control Modes	81

TIP Before you begin, make sure you know the catalog number for each drive component, the Logix module and /or controller used in your motion control application.

Configure the Drive

You can include the drive in your Logix Designer application by adding it to a configured EtherNet/IP module or controller and adding it under the I/O configuration tree. After setting the network configuration, you can view the drive status information in Studio 5000 software and use it in your Logix Designer application.

Set the Network Configuration

You can set the network configuration by using the LCD display and drive keypad.

1. When the LCD display is showing the Device/Axis state, use the keypad to navigate to SETTINGS -> NETWORK. Then choose either STATIC IP or DHCP.
The default setting is STATIC IP.
2. If you chose STATIC IP, then you must configure the following settings:
 - IP address
 - Gateway
 - Subnet mask

If you chose DHCP, the three settings above are configured automatically by the DHCP server.

Settings are stored in nonvolatile memory. IP addressing can also be changed through the Module Configuration dialog box in RSLinx software. Changes to the IP addressing take effect after power is cycled or reset. The drive is factory programmed to static IP address of 192.168.1.180.

See [Configuring Network Settings on page 46](#) for help on configuring the IP settings.

Configure the Logix Designer Application Project

These procedures assume that you have wired your PowerFlex 527 drive system. In this example, the CompactLogix 5370 controller is used.

For help using the Studio 5000 Logix Designer (version 24 or greater) application as it applies to configuring the ControlLogix or CompactLogix controllers, see [Additional Resources on page 7](#).

Configure the Logix5000 Controller

Follow these steps to configure the controller.

1. Apply power to your controller and open your Logix Designer application.



2. From the Create menu, choose New Project.

The New Project dialog box appears.

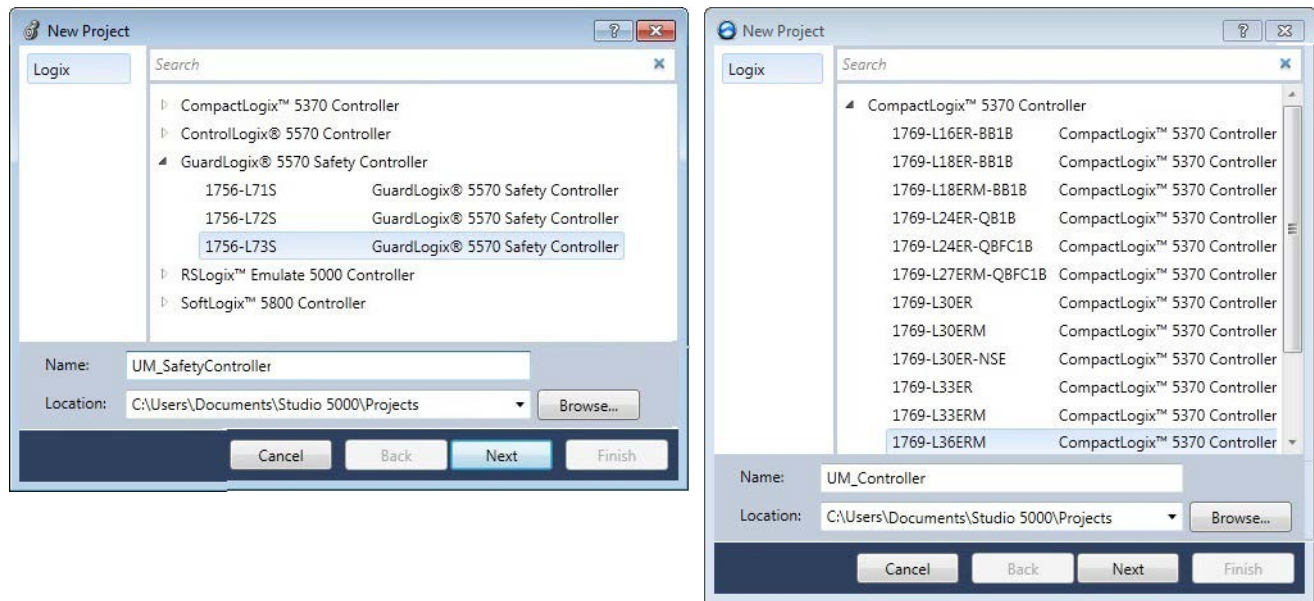

IMPORTANT If you are configuring a PowerFlex 527 drive for integrated safety in a safety application, you must use a GuardLogix safety controller.

If using a safety or non-safety ControlLogix controller, you must also use a 1756-EN2T, 1756-EN2TR, or 1756-EN3TR EtherNet/IP module. If using a CompactLogix 5370 controller, it has dual embedded EtherNet/IP ports.

In this example, the typical dialog boxes for 1756-L7xS GuardLogix 5570 safety controllers and CompactLogix 5370 controllers are shown.

Follow these steps to configure your Logix5000 controller.

1. Expand the Logix5000 controller family and select your controller.
2. Type the file name.
3. Click Next.

The New Project dialog box appears.

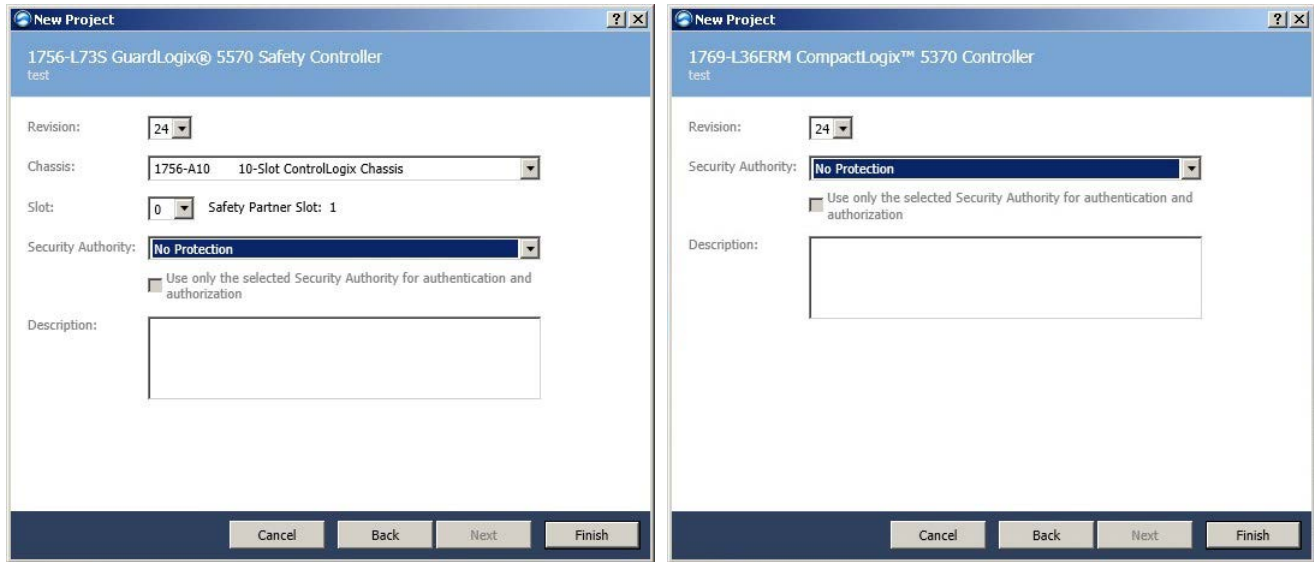

4. From the Revision pull-down menu, choose your software revision.
5. Click Finish.

The new controller appears in the Controller Organizer under the I/O Configuration folder.

Controller Organizer with GuardLogix 1756-7xS controller.



Controller Organizer with CompactLogix 5370 controller.

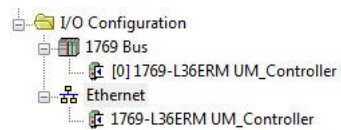

IMPORTANT If your project includes a ControlLogix or GuardLogix controller, you need to add an Ethernet communication module to your Bulletin 1756 chassis and configure it for use in your application.

- For ControlLogix or GuardLogix controllers, go to [step 6](#).
- For CompactLogix 5370 controllers, go to [step 13](#).

See the EtherNet/IP Network Configuration User Manual, publication, [ENET-UM001](#) for more information.

6. Right-click I/O Configuration in the Controller Organizer and choose New Module.

The Select Module Type dialog box appears.

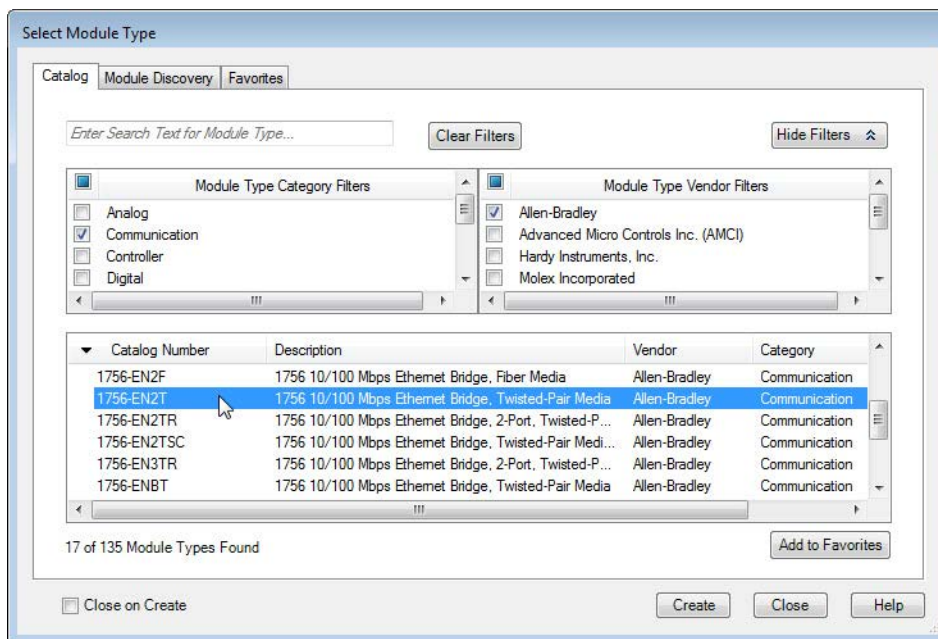

7. By using the filters, check Communication and Allen-Bradley, and select 1756-EN2T, 1756-EN2TR, or 1756-EN3TR as appropriate for your actual hardware configuration. In this example, the 1756-EN2T module is selected.
8. Click Create.

The New Module dialog box appears.

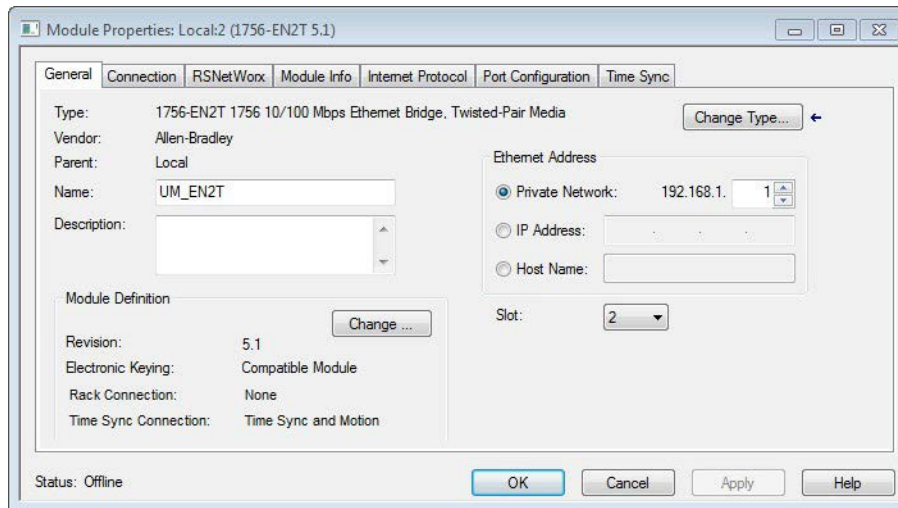

- a. Configure the new module.
- b. Type the module name.
- c. Enter the Logix EtherNet/IP module slot (leftmost slot = 0).
- d. Select an Ethernet Address option. In this example, the Private Network address is selected.

- e. Enter the address of your EtherNet/IP module.
In this example, the last octet of the address is 1.
- f. Click Change in the Module Definition area.

The Module Definition dialog box opens.

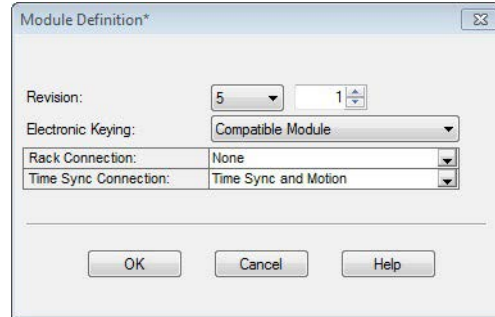

- 9. From the Time Sync Connection pull-down menu, choose Time Sync and Motion.

IMPORTANT Time Sync functionality is what enables motion control on an Ethernet network. Without this setting, you won't be able to run your motion application.

- 10. Click OK to close the Module Definition dialog box.
- 11. Click Yes when prompted to confirm your module definition changes.

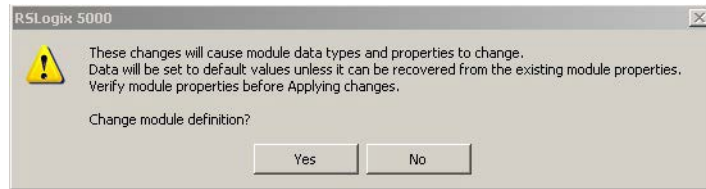

- 12. Click OK to close the New Module dialog box.

Your new 1756-ENxT Ethernet module appears under the I/O configuration folder in the Controller Organizer.

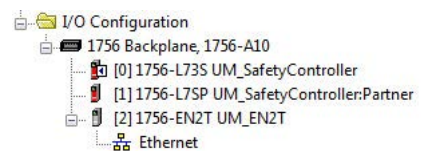

- 13. From the Edit menu, choose Controller Properties.

The Controller Properties dialog box appears.

- Click the Date/Time tab.

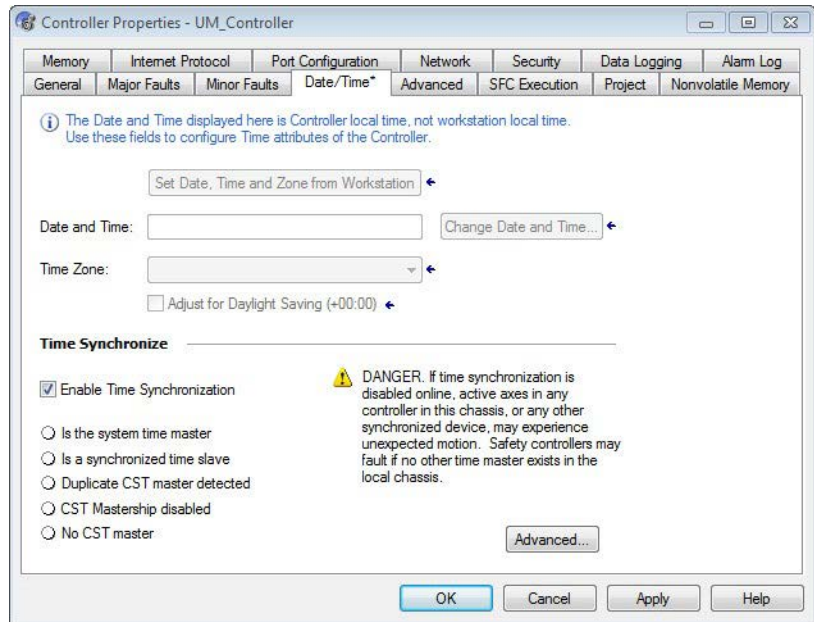

- Check Enable Time Synchronization.

The motion modules set their clocks to the module you assign as the Grandmaster.

IMPORTANT Check Enable Time Synchronization for all controllers that participate in CIP Sync. The overall CIP Sync network automatically promotes a Grandmaster clock, unless the priority is set in the Advanced tab.

- Click OK.

Add a PowerFlex 527 Drive

Follow these instructions to add the PowerFlex 527 drive to your project.

- Right-click the Ethernet network (node) and choose New Module...

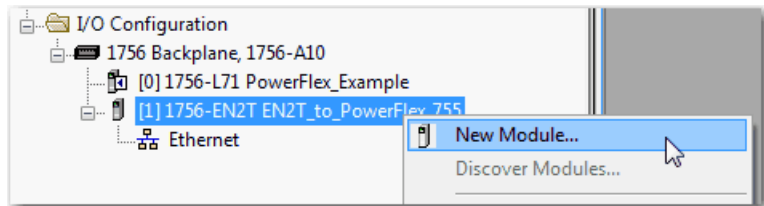

- Clear the small 'select all' check boxes, Module Type Category and Vendor Filters.
Alternatively, you can simply type "527" into the search box and choose the drive.

3. In the Module Type Vendors Filters window, check Allen-Bradley. In the Module Type Category Filters window, check Drive.

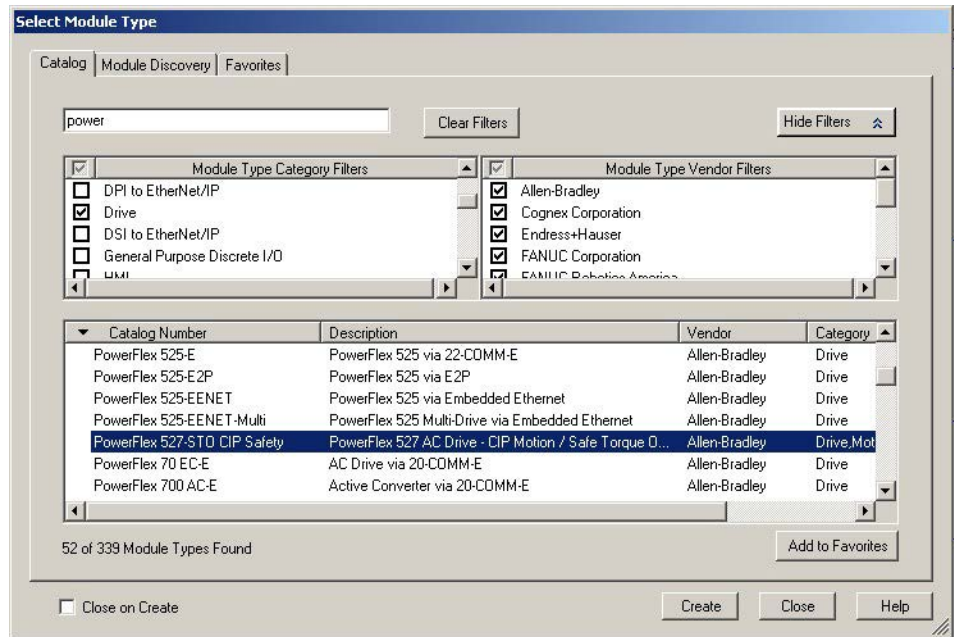

4. Choose the PowerFlex 527 drive and click create.

The Module Properties dialog box appears.

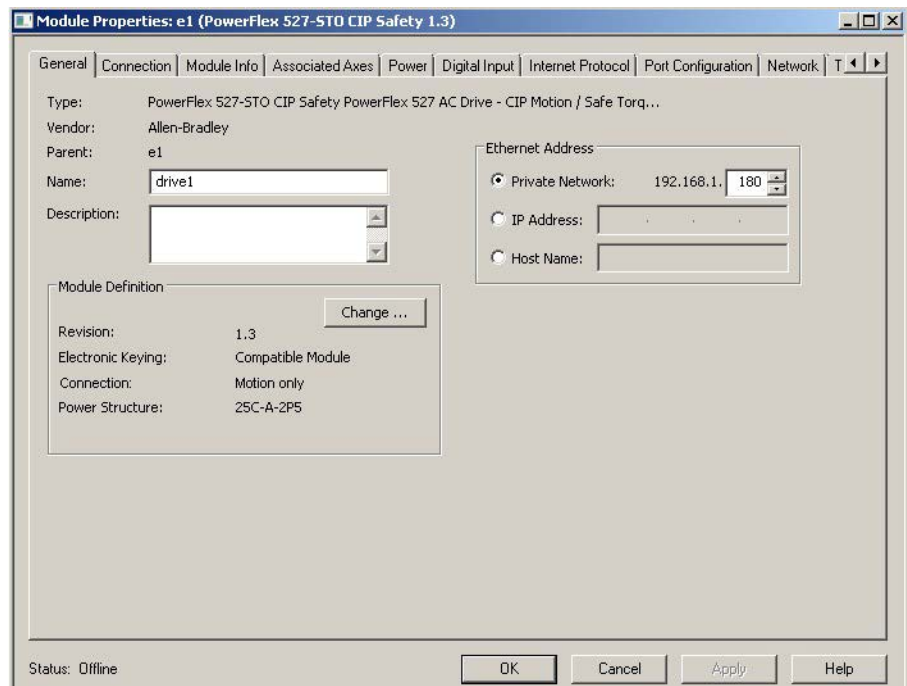

5. Configure the new drive.
 - a. Type the drive Name.
 - b. Type a description, if desired.
 - c. Select an Ethernet Address option.
In this example, the Private Network address is selected.

- d. Enter the address of your PowerFlex 527 drive.
In this example, the last octet of the address is 180.

- 6. Proceed to [Configure the PowerFlex 527 Drive on page 57](#) to continue configuring your drive.

Configure the PowerFlex 527 Drive

After you have added a PowerFlex 527 drive to your project, you will need to configure the type of safety connection suitable for your application. See the following sections for instructions on configuring the drive for the different types of safety connections.

- [Configure Drive with Hardwired Safety Connections on page 57](#)
- [Configure Drive with Integrated Safety Connections on page 59](#)

Connection Mode	Controller Needed	Description
Motion only	ControlLogix 1756-L7x, GuardLogix 1756-L7xS, or CompactLogix 5370	Hardwired Safe Torque-Off (STO) connections are possible. Motion is managed by this controller. Safety is managed by another controller that has a Safety only connection to the drive.
Motion and Safety	GuardLogix 1756-L7xS	Motion and Safety are managed by this controller.
Safety only	GuardLogix 1756-L7xS	Safety is managed by this controller. Motion is managed by another controller that has a Motion only connection to the drive.

IMPORTANT To configure PowerFlex 527 drives, you must be using the Logix Designer application, version 24.00 or later.

Configure Drive with Hardwired Safety Connections

Follow these steps to configure the PowerFlex 527 drives with hardwired safety.

1. Ensure that you have done the steps in [Add a PowerFlex 527 Drive on page 55](#) before proceeding.
2. Under Module Definition, click Change.

The Module Definition dialog box appears.

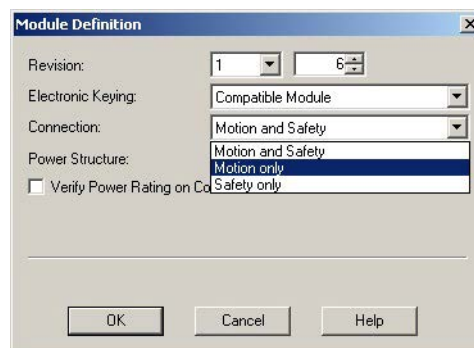

- a. From the Electronic Keying pull-down menu, choose an option.



WARNING: When using motion modules, the electronic keying must be either “Exact Match” or “Compatible Keying”.

Never use “Disable Keying” with motion modules.

- b. From the Connection pull-down menu, choose the Connection mode for your motion application.

In this example, choose Motion only.

TIP When ‘Safety’ appears in the Connection mode, integrated safety is implied.

- c. From the Power Structure pull-down menu, choose the catalog number that matches your power structure.

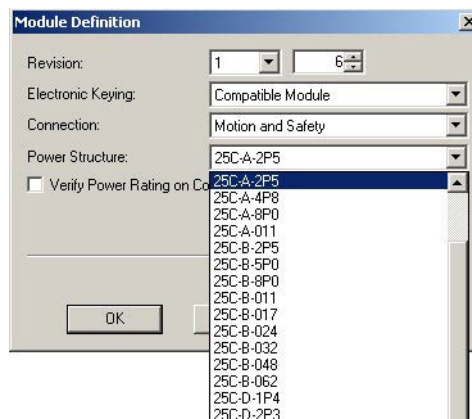

- d. Check the Verify Power Rating On Connection check box to ensure that the proper power structure defined in the profile is the same as the connected drive. If the two do not match, a connection error occurs, which indicates a power mismatch.

Verify Power Rating on Connection is checked by default. It is enabled in offline mode.

3. Click OK to close the Module Definition dialog box.

4. Click OK to close the Module Properties dialog box.

Your PowerFlex 527 drive appears in the Controller Organizer under the Ethernet controller in the I/O configuration folder.

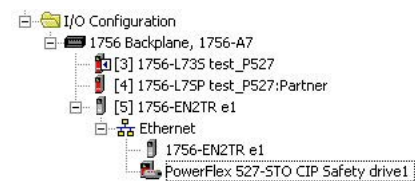

5. Proceed to [Continue Drive Configuration on page 62](#) to continue configuring your drive.

Configure Drive with Integrated Safety Connections

Follow these steps to configure PowerFlex 527 drives with integrated safety.

1. Ensure that you have done the steps in [Add a PowerFlex 527 Drive on page 55](#) before proceeding.
2. Under Module Definition, click Change.

The Module Definition dialog box appears.

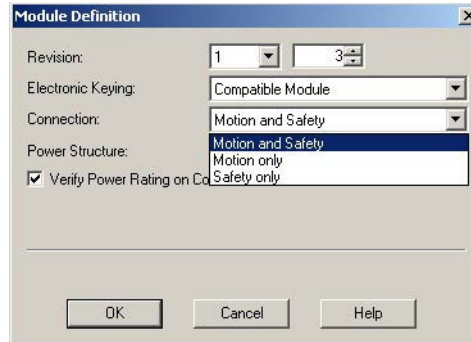

- a. From the Electronic Keying pull-down menu, choose an option.



WARNING: When using motion modules, the electronic keying must be either “Exact Match” or “Compatible Keying”.
Never use “Disable Keying” with motion modules.

- b. From the Connection pull-down menu, choose the Connection mode for your motion application.
In this example, choose Motion and Safety.

TIP When ‘Safety’ appears in the Connection mode, integrated safety is implied.

The Safety Network Number (SNN) field populates automatically when the Connection mode includes an integrated Motion and Safety or Safety-only connection. For a detailed explanation of the safety network number, see the GuardLogix Controller Systems Safety Reference Manual, publication [1756-RM099](#).

- c. From the Power Structure pull-down menu, choose the catalog number that matches your power structure.

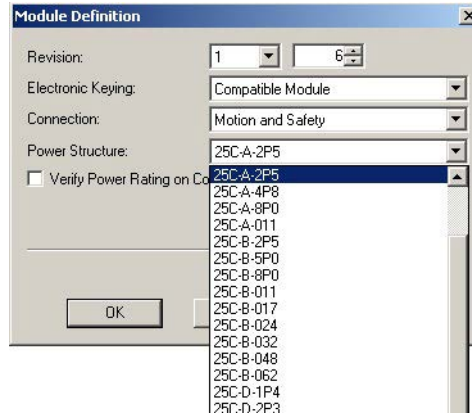

- d. Check the Verify Power Rating On Connection check box to ensure that the proper power structure defined in the profile is the same as the connected drive. If the two do not match, a connection error occurs, which indicates a power mismatch. Verify Power Rating on Connection is checked by default. It is enabled in offline mode.

3. Click OK to close the Module Definition dialog box.

4. Click the Safety tab.

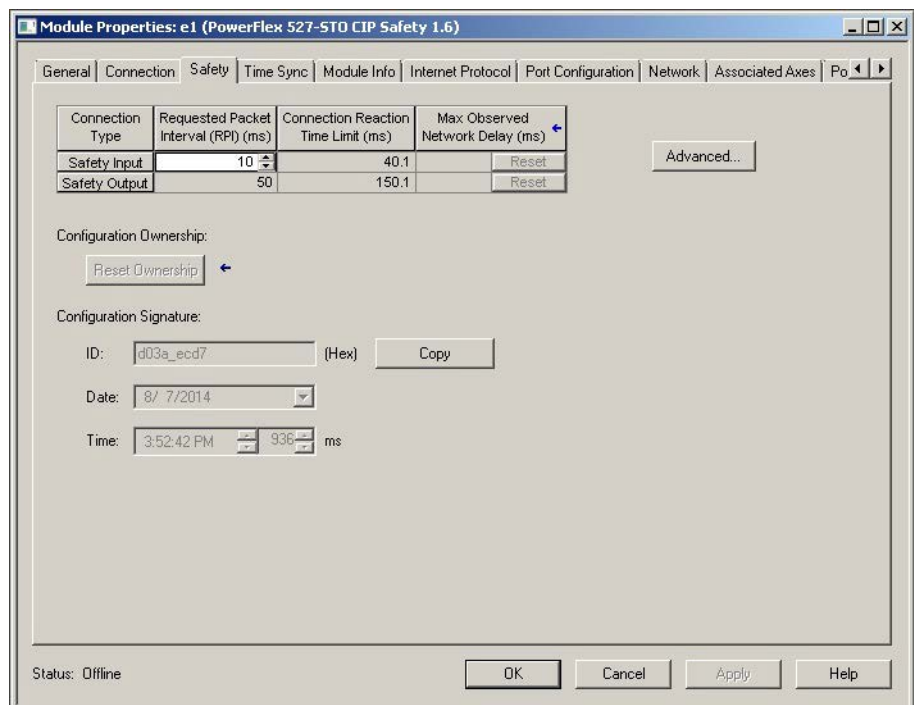

The connection between the controller and the PowerFlex 527 drive is based on the following:

- Drive catalog number must be PowerFlex 527 (integrated)
- Drive Safety Network Number (SNN)
- GuardLogix slot number

- GuardLogix safety network number
- Path from the GuardLogix controller to the PowerFlex 527 drive.
- Configuration signature

If any differences are detected, the connection between the GuardLogix controller and the PowerFlex 527 drive is lost, and the yellow icon appears in the controller project tree after you download the program.

5. Click Advanced.

The Advanced Connection Reaction Time Limit Configuration dialog box appears.

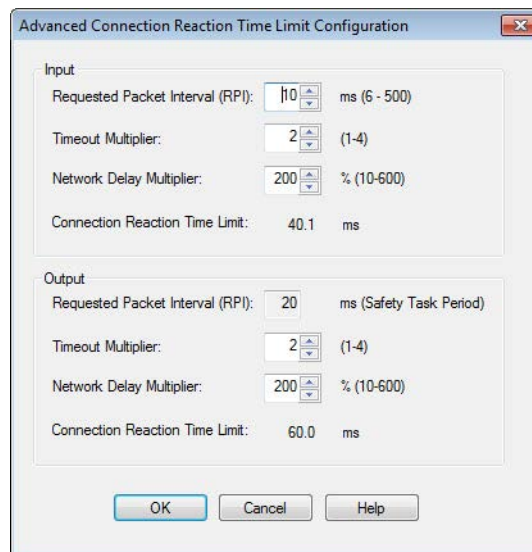

Analyze each safety channel to determine the appropriate settings. The smallest Input RPI allowed is 6 ms. Selecting small RPI values consumes network bandwidth and can cause nuisance trips because other devices cannot get access to the network.

For more information about the Advanced Connection Reaction Time Limit Configuration, see the GuardLogix 5570 Controllers User Manual, publication [1756-UM022](#).

6. Click OK to close the Advanced Connection Reaction Time Limit Configuration dialog box.
7. Click OK to close the Module Properties dialog box.

Your PowerFlex 527 drive appears in the Controller Organizer under the Ethernet controller in the I/O Configuration folder.

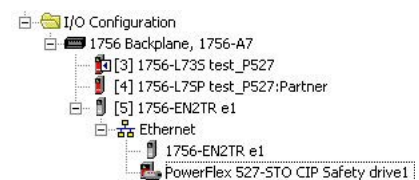

8. Proceed to [Continue Drive Configuration on page 62](#) to continue configuring your drive.

Continue Drive Configuration

After you have established your PowerFlex 527 drive in the Logix Designer application, the remaining configuration steps are the same regardless of the drive catalog number.

1. Right-click the PowerFlex 527 drive you just created and choose Properties.

The Module Properties dialog box appears.

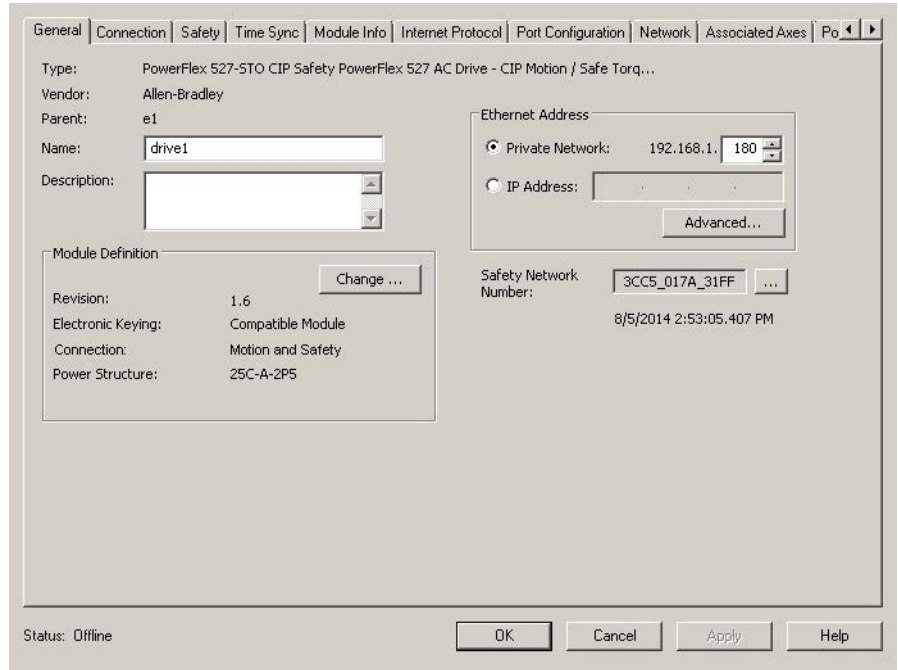

2. Click the Associated Axes tab.



3. Click New Axis.

The New Tag dialog box appears.

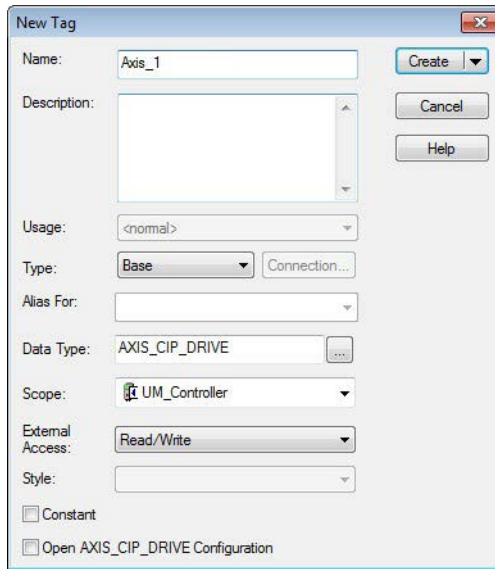

4. Type the axis Name.
AXIS_CIP_DRIVE is the default Data Type.
5. Click Create.

The axis (Axis_1 in this example) appears in the Controller Organizer under Motion Groups > Ungrouped Axes and is assigned as Axis 1.

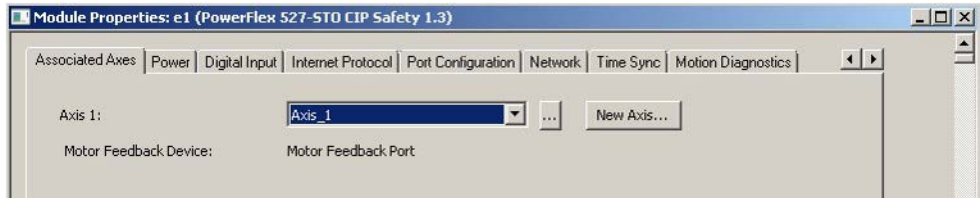

6. Click Apply

7. Click the Power tab.

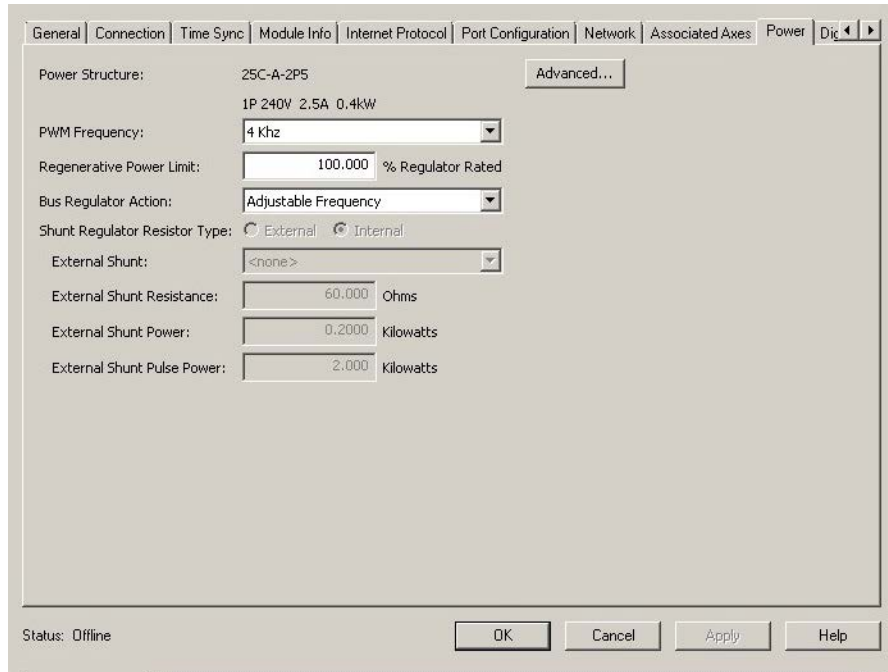

8. From the pull-down menu, choose the power options appropriate for your actual hardware configuration.

Attribute	Menu	Description
PWM Frequency	<ul style="list-style-type: none"> 2 kHz 4 kHz 8 kHz 	The value sets the carrier frequency for the Pulse Width Modulation (PWM) output to the motor.
Bus Regulator Action	Disabled	This selection disables the drive's internal DC bus voltage regulation feature. Select this option if there is an external regenerative brake or regenerative line supply connected to the drive DC bus.
	Shunt Regulator	This selection is used when either an external shunt resistor is connected to the drive or the internal IGBT will be controlling the power dissipation to the resistor (the type of shunt resistor is selected below).
	Adjustable Frequency (Default)	This selection allows the drive to either change the torque limits or ramp rate of the velocity to control the DC bus voltage. This option is not recommended for positioning applications because it will override the velocity and the system will overshoot or may not stop.
	Shunt then Adjustable Frequency	This selection allows the Shunt resistor to absorb as much energy as it is designed for, then transitions to adjustable frequency control if the limit of the resistor has been reached.
	Adjustable Frequency then Shunt	This selection allows for adjustable frequency control of the DC bus. If adjustable frequency control cannot maintain the DC bus within limits, the shunt resistor will be activated.
Shunt Regulator Resistor Type	Internal	Not applicable for PowerFlex 527 drives.
	External	Enables the external shunt (internal shunt option is disabled).

9. Click OK.

10. Repeat [step 1](#) through [step 9](#) for each PowerFlex 527 drive.

Configure the Motion Group

Follow these steps to configure the motion group.

1. In the Controller Organizer, right-click Motion Groups and choose New Motion Group.

The New Tag dialog box appears.

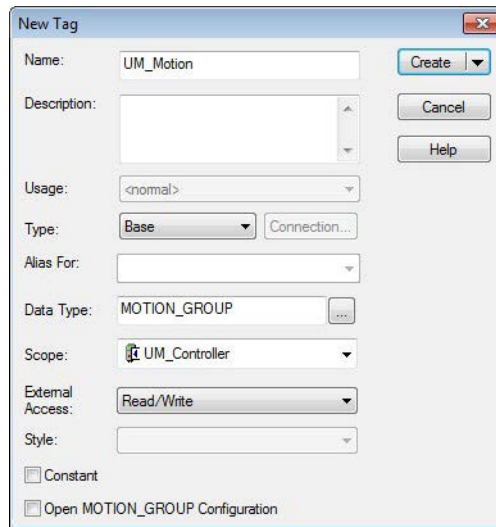

2. Type the new motion group name.
3. Click Create.

Your new motion group appears in the Controller Organizer under the Motion Groups folder.



4. Right-click the new motion group and choose Properties.

The Motion Group Properties dialog box appears.

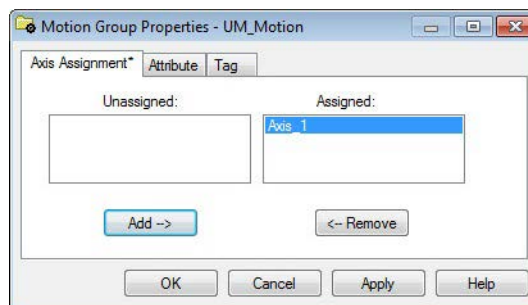

5. Click the Axis Assignment tab and move your axes (created earlier) from Unassigned to Assigned.
6. Click the Attributes tab and edit the default values as appropriate for your application.
7. Click OK.

Your axis moves to the new motion group.

To get the minimum motion group base update rate, see [Motion Group Base Update Rate on page 163](#).

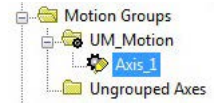

Configure Axis Properties

Axis configuration depends on the motor or other devices (for example, an external encoder) associated with each axis. This section provides guidelines for configuring induction motors.

- [Configure Induction Motor Axis Properties \(Frequency Control\) on page 66](#)
- [Configure Induction Motors Axis Properties \(Velocity Loop\) on page 71](#)
- [Configure Induction Motors Axis Properties \(Position Loop\) on page 75](#)

Configure Induction Motor Axis Properties (Frequency Control)

The PowerFlex 527 drives support basic Volts/Hertz (V/Hz), Fan/Pump Volts/Hertz, Sensorless Vector Control (SVC), and Sensorless Vector Control (SVC) Economy frequency control methods.

Follow these steps to configure the induction motor axis properties.

1. In the Controller Organizer, right-click an axis and choose Properties.
2. Select the General category.

The General and Associated Module dialog box appears.

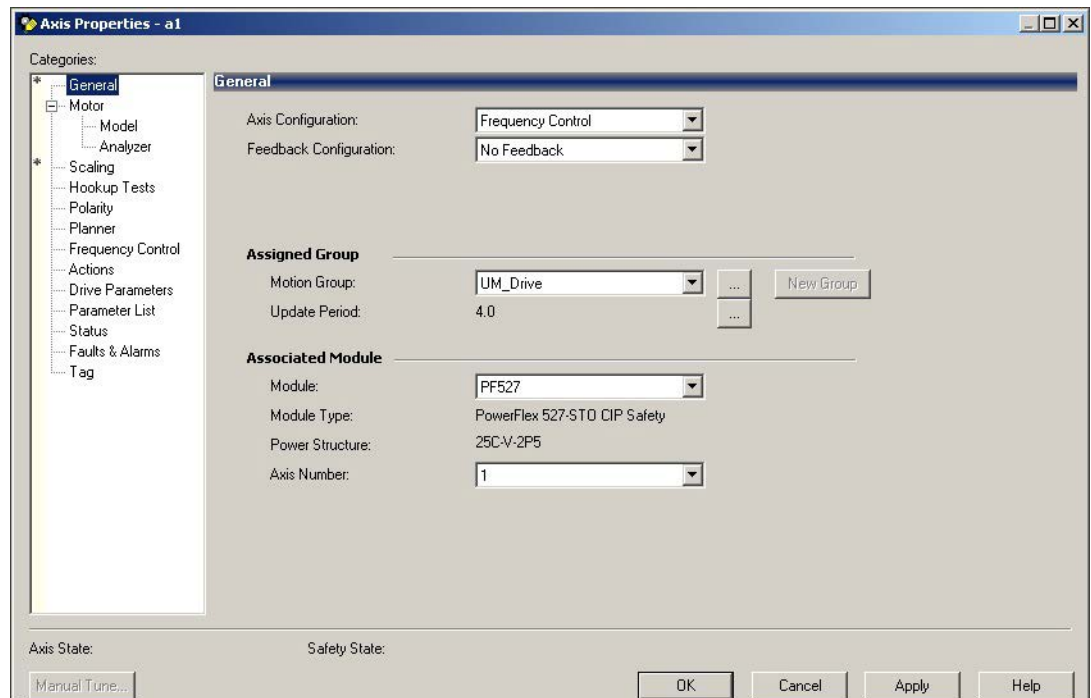

3. From the Axis Configuration pull-down menu, choose Frequency Control.
4. From the Module pull-down menu, your PowerFlex 527 drive.

The Module Type and Power Structure fields populate with the chosen drive catalog number.

5. Click Apply.
6. Select the Motor category.

The Motor Device Specification dialog box appears.

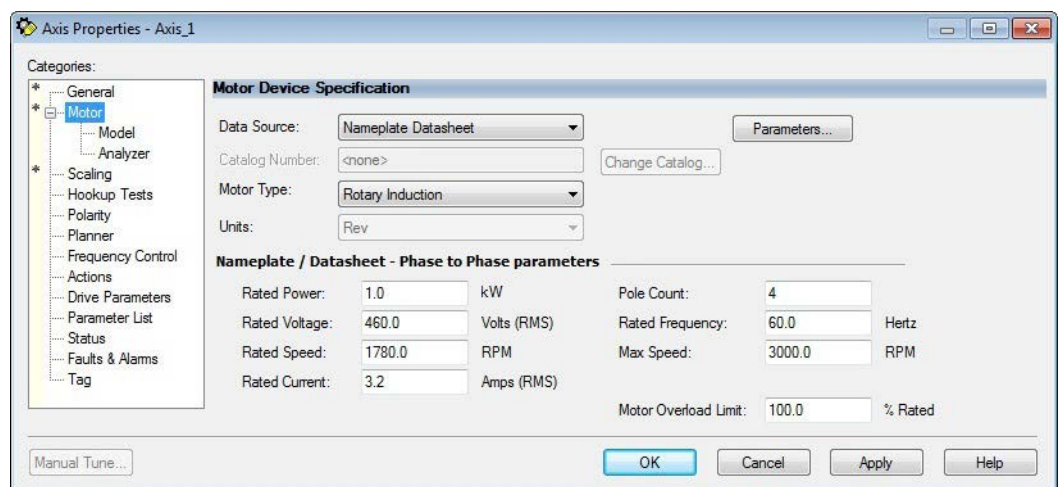

7. From the Data Source pull-down menu, choose Nameplate Datasheet. This is the default setting.

8. From the Motor Type pull-down menu, choose Rotary Induction.
9. From the motor nameplate or datasheet, enter the phase-to-phase values.
10. Click Apply.
11. Select the Frequency Control category.

The Frequency Control dialog box appears.

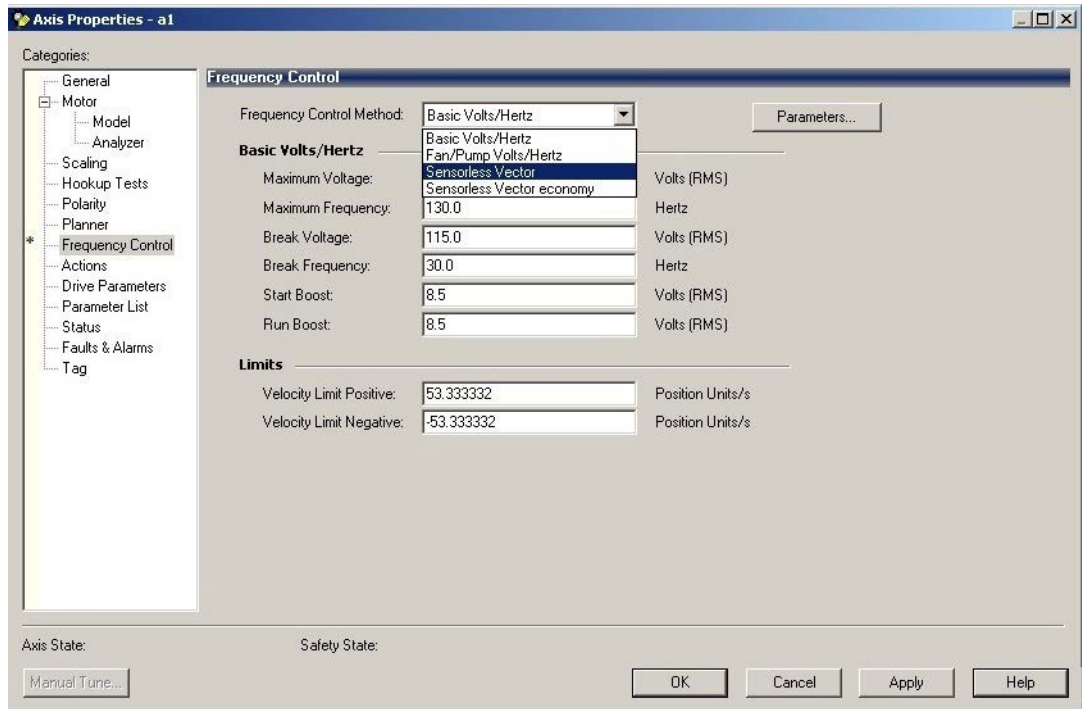

12. From the Frequency Control Method pull-down menu, choose the method appropriate for your application.
13. If you chose the Basic Volts/Hertz method, enter the nameplate data for your motor in the Basic Volts/Hertz fields.

If you chose the Sensorless Vector method, the Basic Volts/Hertz fields are dimmed.

14. Click Apply.
15. If you chose the Sensorless Vector or Sensorless Vector Economy method, select the Motor > Analyzer category.

The Analyze Motor to Determine Motor Model dialog box appears.

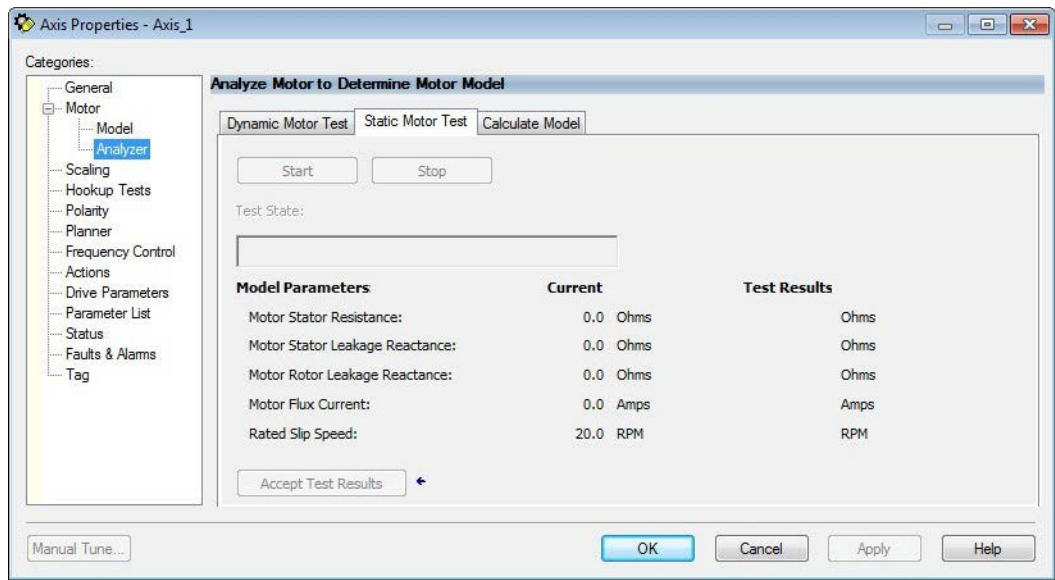

16. Click the Static Motor Test tab.
17. Click Start to run the test and measure Motor Stator Resistance. If you chose the Basic Volts/Hertz category, you can skip this test.
18. Select the Actions category.

The Actions to Take Upon Conditions dialog box appears.

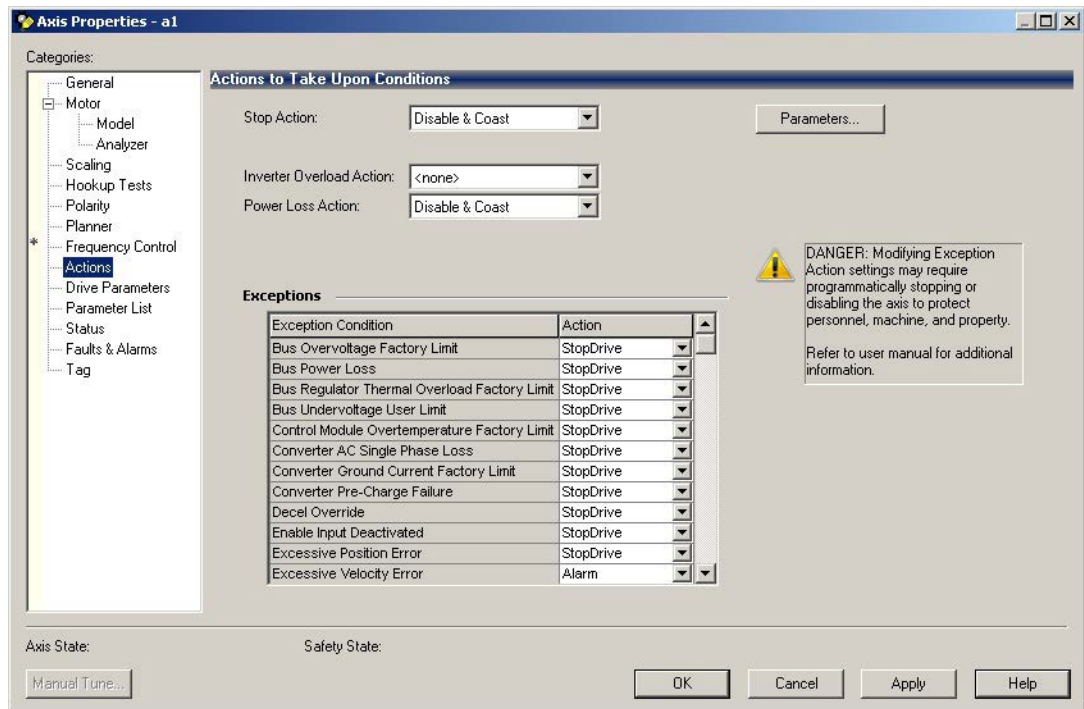

From this dialog box, you can program actions and change the action for exceptions (faults). See [Logix5000 Controller and Drive Behavior on page 127](#) for more information.

Some out-of-box (OOB) settings will need to be applied here. See [Recommended Out-of-Box Settings on page 161](#) for more information.

19. Select the Parameter List category.

The Motion Axis Parameters dialog box appears.

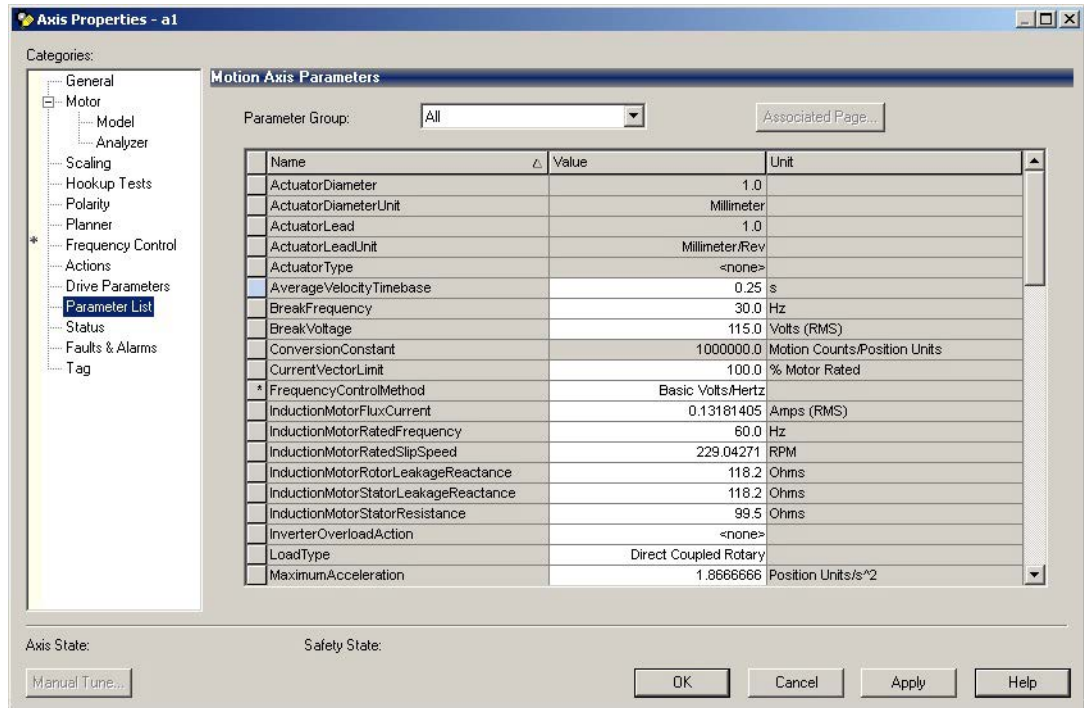

From this dialog box, you can program actions and change the action for exceptions (faults). See [Logix5000 Controller and Drive Behavior on page 127](#) for more information.

To obtain the best performance from the drive regardless of which control method you are using, you should configure the recommended out-of-box settings as described in [Recommended Out-of-Box Settings on page 161](#) first before configuring further for your application.

20. Click OK.
21. Repeat [step 1](#) through [step 20](#) for each induction motor axis.

Configure Induction Motors Axis Properties (Velocity Loop)

Follow these steps to configure the induction motor axis properties.

1. In the Controller Organizer, right-click an axis and choose Properties.
2. Select the General category.

The General and Associated Module dialog box appears.

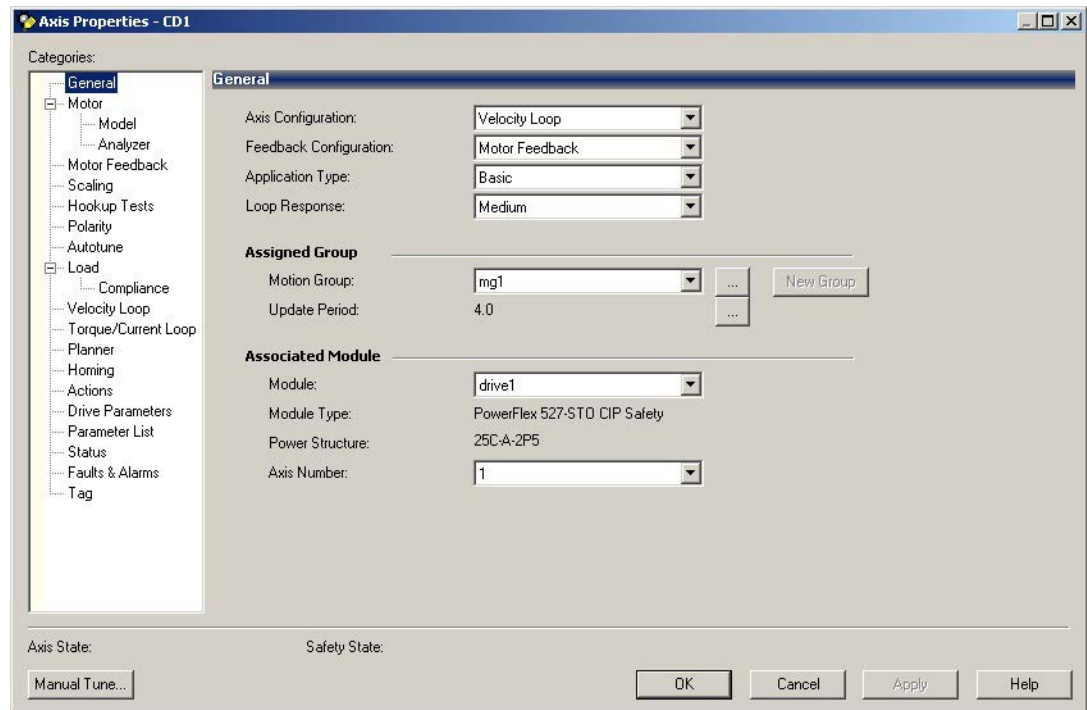

3. From the Axis Configuration pull-down menu, choose Velocity Loop.
4. From the Module pull-down menu, your PowerFlex 527 drive.

The Module Type and Power Structure fields populate with the chosen drive catalog number.

5. Click Apply.
6. Select the Motor category.

The Motor Device Specification dialog box appears.

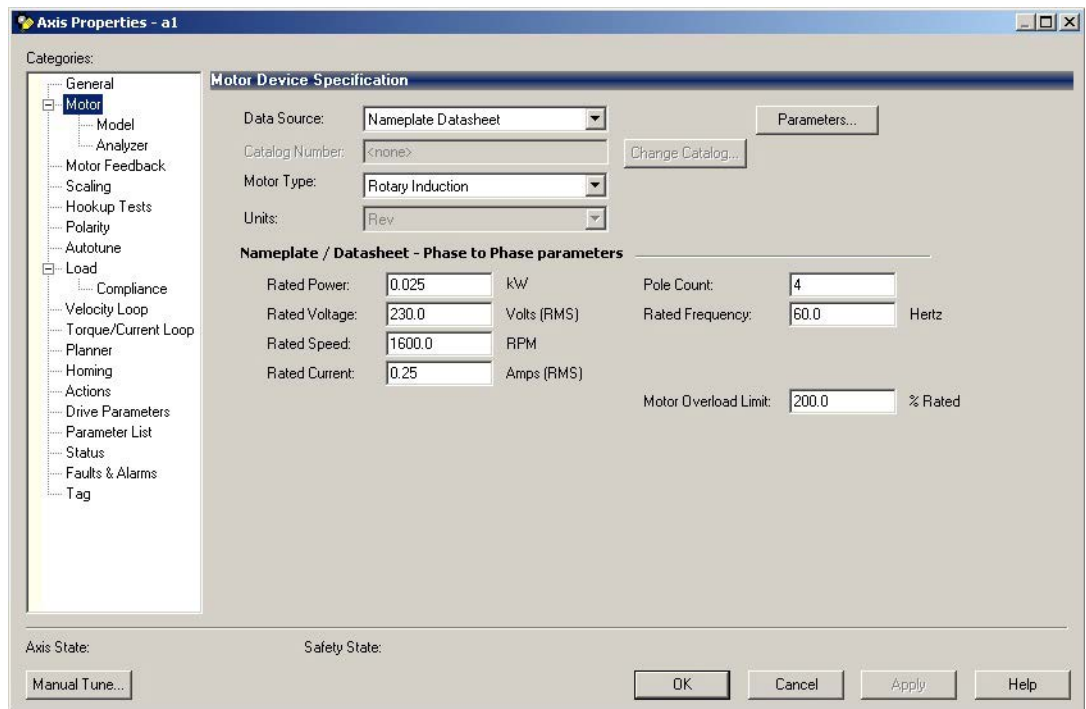

7. From the Data Source pull-down menu, choose Nameplate Datasheet. This is the default setting.
8. From the Motor Type pull-down menu, choose Rotary Induction.
9. From the motor nameplate or datasheet, enter the phase-to-phase values.
10. Click Apply.
11. Select the Motor Feedback category.

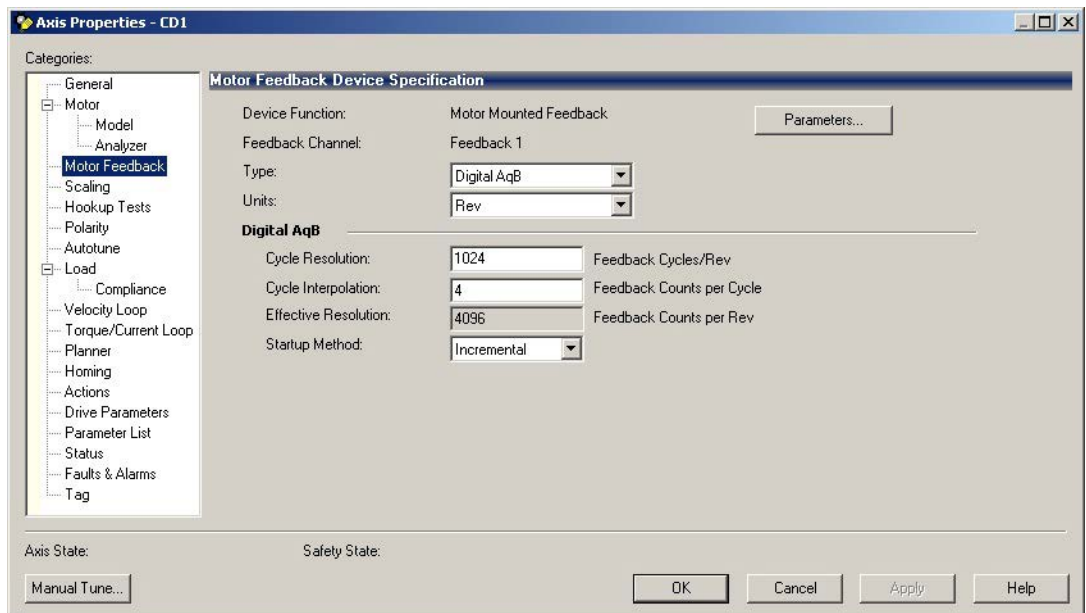

12. Enter the specifications of your encoder into the fields.

13. Click Apply.
14. Select the Scaling category and edit the values as appropriate for your application.

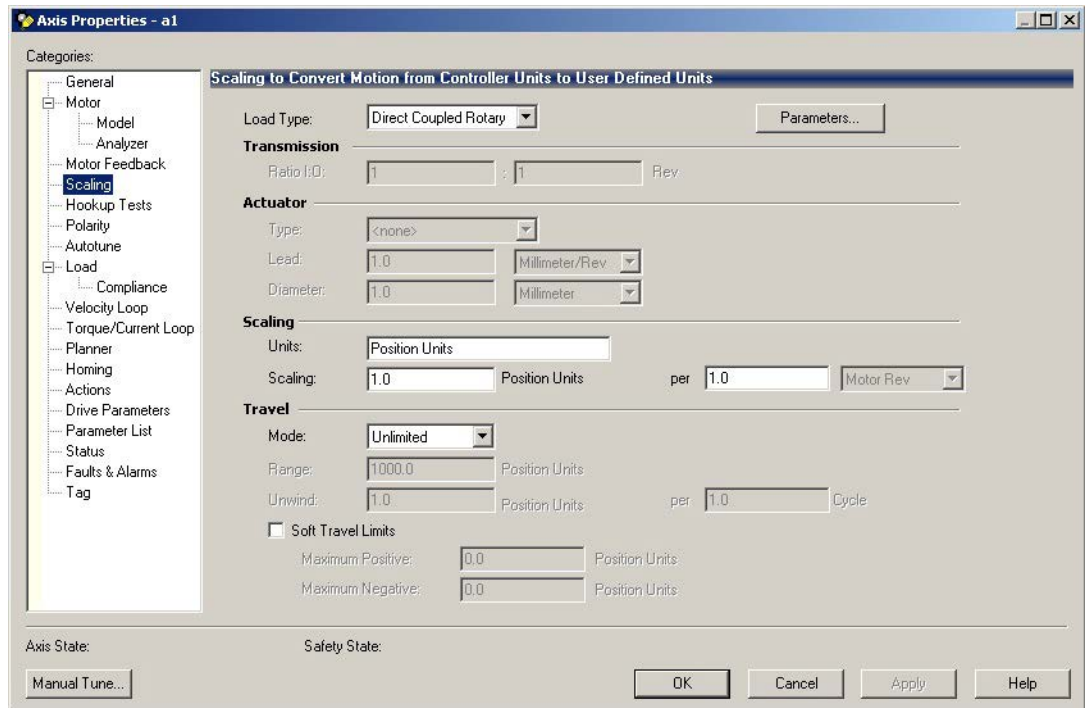

15. Click Apply if you make changes.
16. Select the Actions category.

The Actions to Take Upon Conditions dialog box appears.

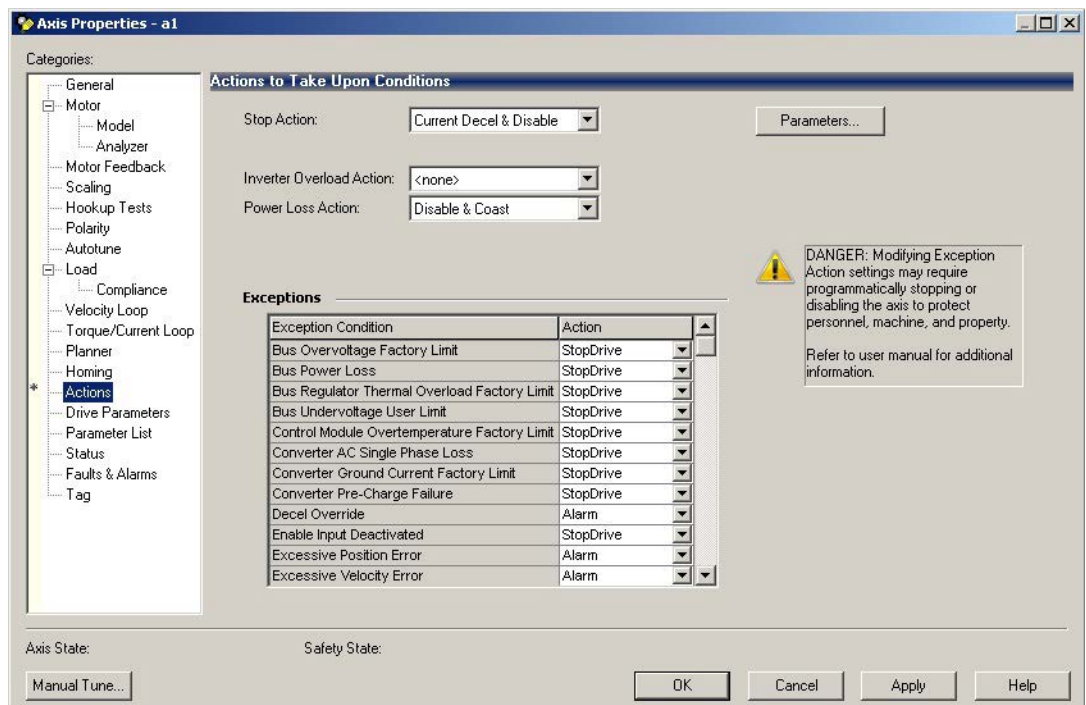

From this dialog box, you can program actions and change the action for exceptions (faults). See [Logix5000 Controller and Drive Behavior on page 127](#) for more information.

Some out-of-box (OOB) settings will need to be applied here. See [Recommended Out-of-Box Settings on page 161](#) for more information.

17. Select the Parameter List category.

The Motion Axis Parameters dialog box appears.

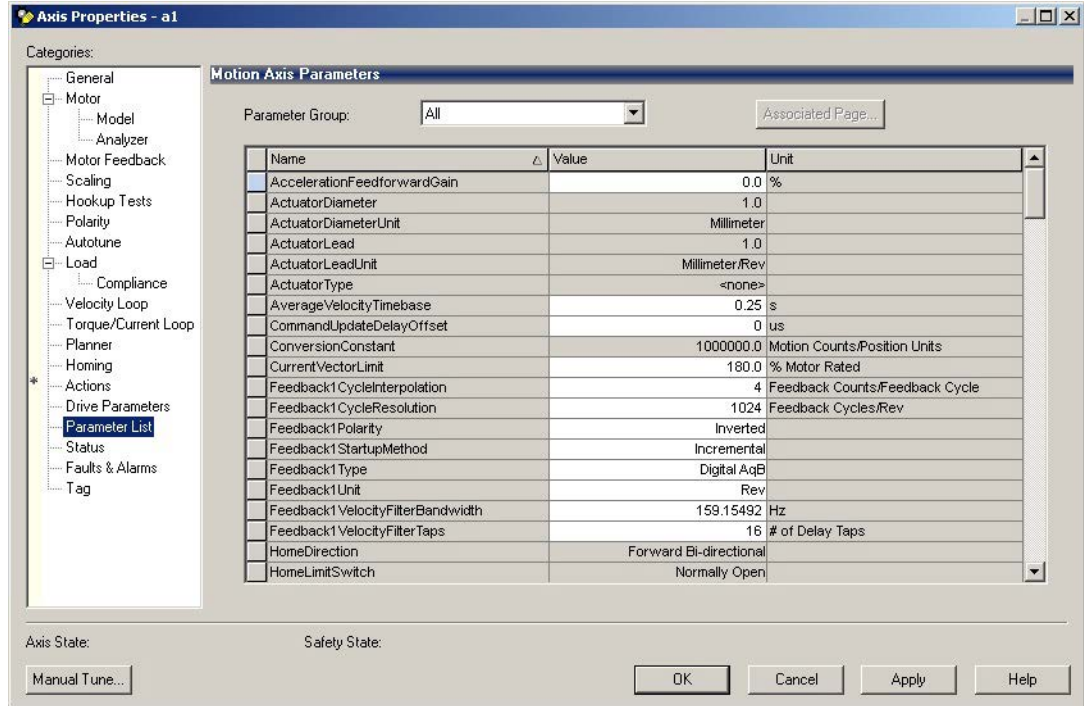

From this dialog box, you can program actions and change the action for exceptions (faults). See [Logix5000 Controller and Drive Behavior on page 127](#) for more information.

To obtain the best performance from the drive regardless of which control method you are using, you should configure the recommended out-of-box settings as described in [Recommended Out-of-Box Settings on page 161](#) first before configuring further for your application.

18. Click OK.
19. Repeat [step 1](#) through [step 18](#) for each induction motor axis.

Configure Induction Motors Axis Properties (Position Loop)

Follow these steps to configure the induction motor axis properties.

1. In the Controller Organizer, right-click an axis and choose Properties.
2. Select the General category.

The General and Associated Module dialog box appears.

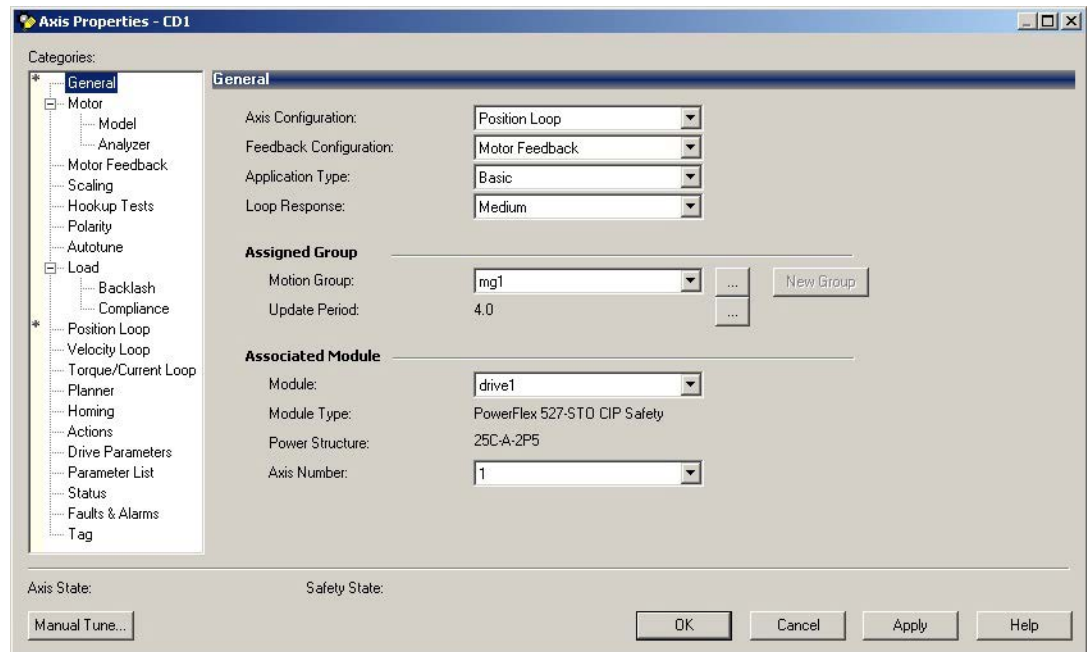

3. From the Axis Configuration pull-down menu, choose Position Loop.
4. From the Module pull-down menu, your PowerFlex 527 drive.

The Module Type and Power Structure fields populate with the chosen drive catalog number.

5. Click Apply.
6. Select the Motor category.

The Motor Device Specification dialog box appears.

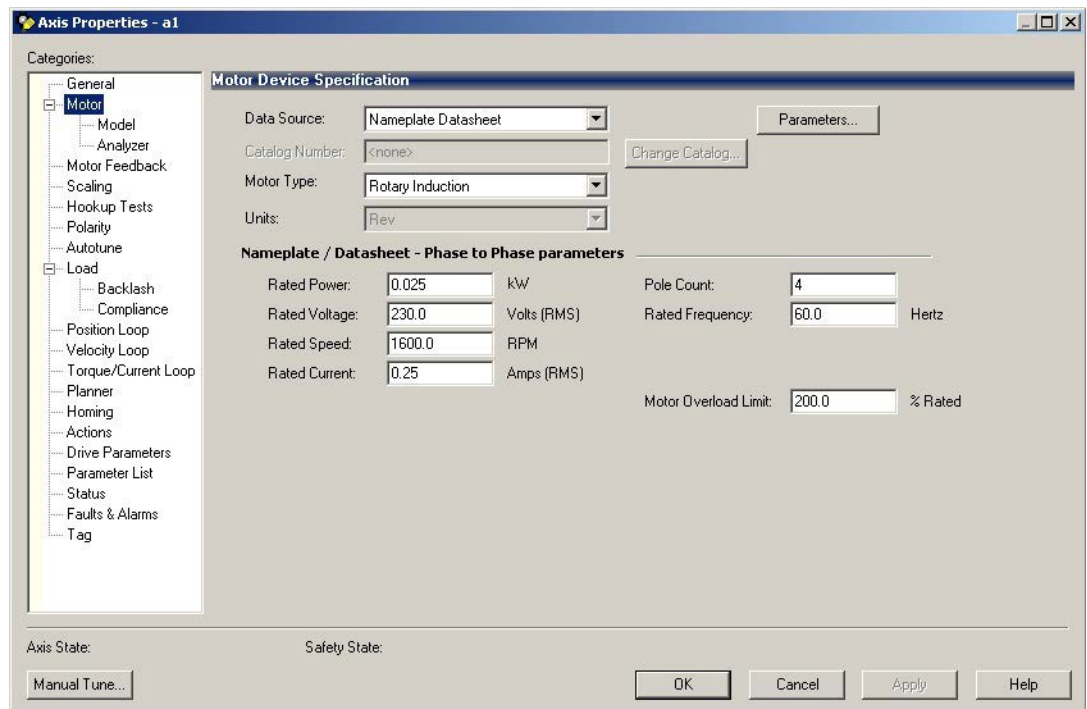

7. From the Data Source pull-down menu, choose Nameplate Datasheet. This is the default setting.
8. From the Motor Type pull-down menu, choose Rotary Induction.
9. From the motor nameplate or datasheet, enter the phase-to-phase values.
10. Click Apply.

11. Select the Motor Feedback category.

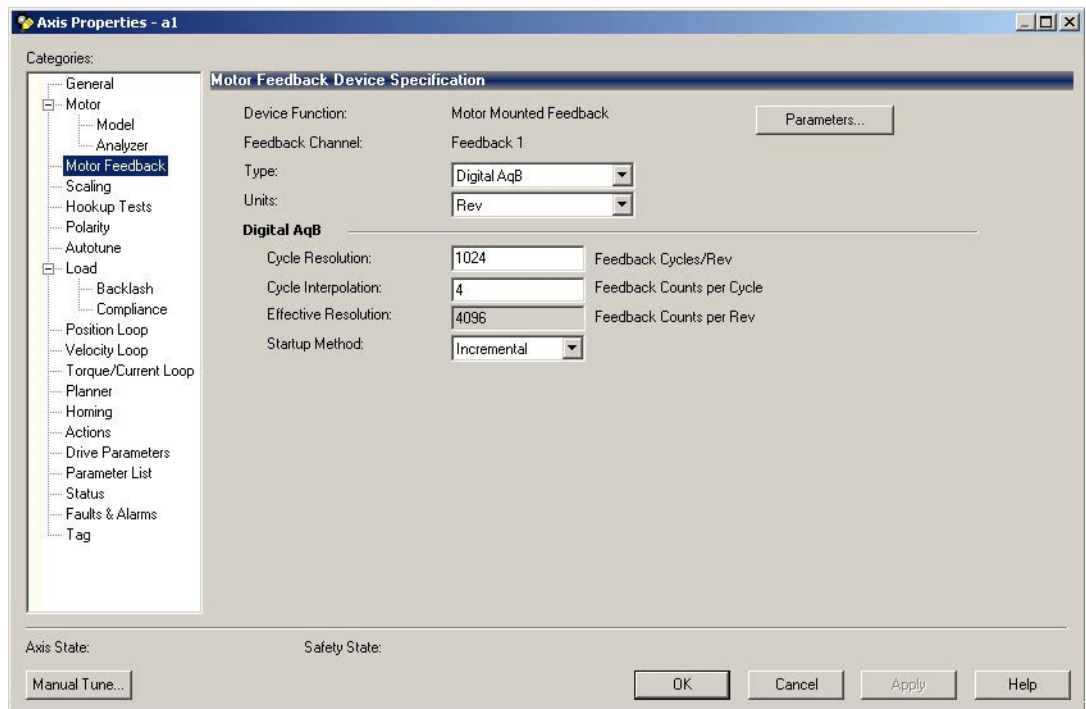

12. Enter the specifications of your encoder into the fields.

13. Click Apply.

14. Select the Scaling category and edit the values as appropriate for your application.

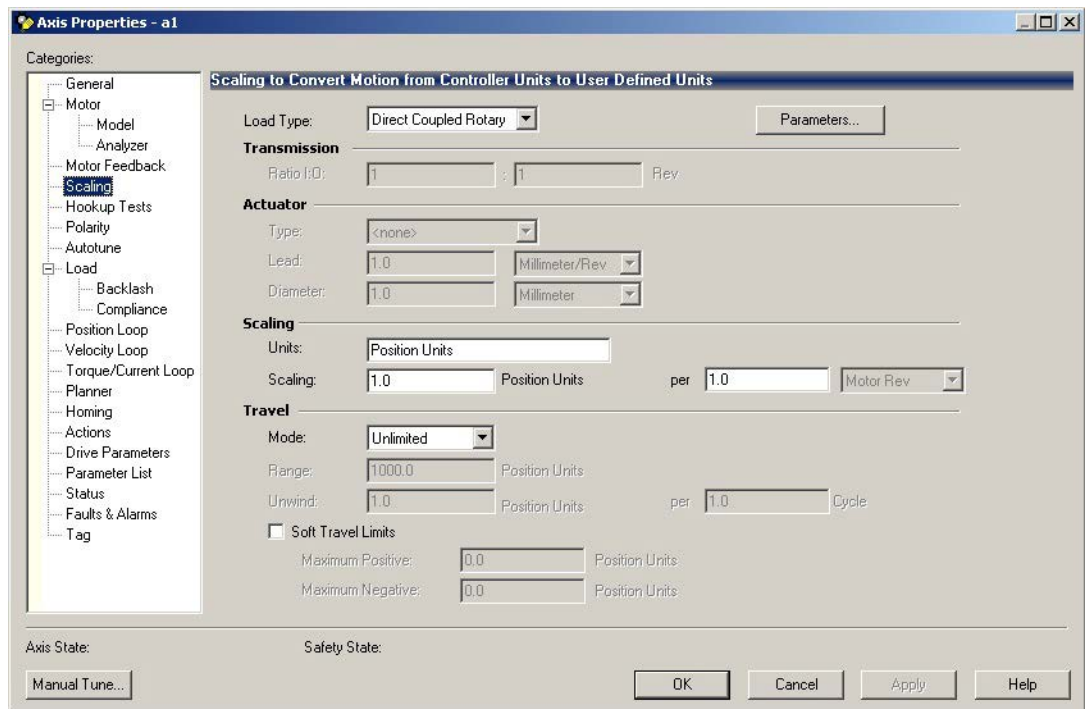

15. Click Apply if you make changes.

16. Select the Actions category.

The Actions to Take Upon Conditions dialog box appears.

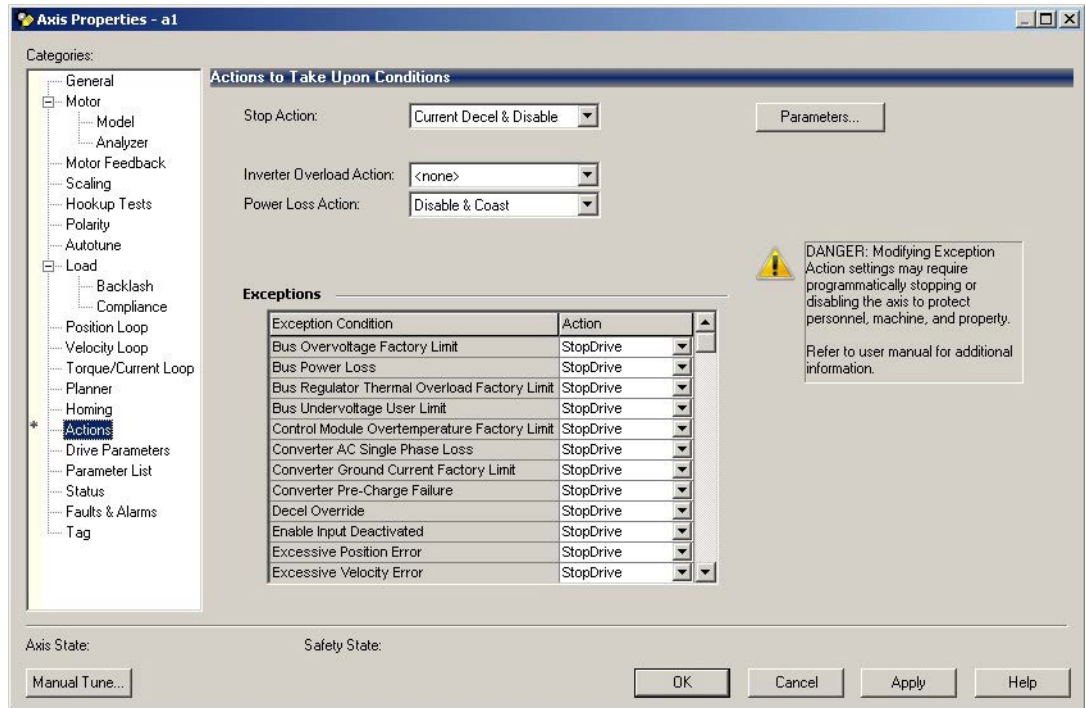

From this dialog box, you can program actions and change the action for exceptions (faults). See [Logix5000 Controller and Drive Behavior on page 127](#) for more information.

Some out-of-box (OOB) settings will need to be applied here. See [Recommended Out-of-Box Settings on page 161](#) for more information.

17. Select the Parameter List category.

The Motion Axis Parameters dialog box appears.

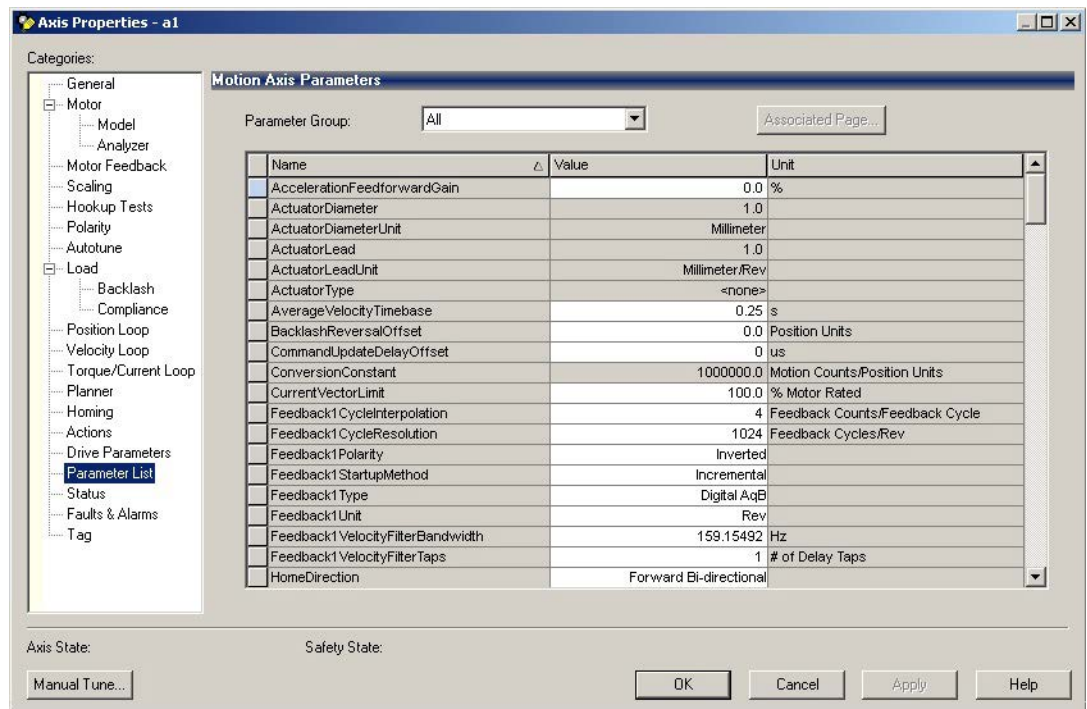

From this dialog box, you can program actions and change the action for exceptions (faults). See [Logix5000 Controller and Drive Behavior on page 127](#) for more information.

To obtain the best performance from the drive regardless of which control method you are using, you should configure the recommended out-of-box settings as described in [Recommended Out-of-Box Settings on page 161](#) first before configuring further for your application.

18. Click OK.
19. Repeat [step 1](#) through [step 18](#) for each induction motor axis.

Download the Program

After completing the Logix Designer application and saving the file, you must download your program to the Logix5000 processor.

Apply Power to the PowerFlex 527 Drive

This procedure assumes that you have done the following:

- Wired and configured your PowerFlex 527 system and your Logix5000 controller.
- Downloaded the project to the controller.
- Connected the Ethernet port to the drive.

If you have not done the steps listed above, you will achieve a different result in step 5 as shown below.



SHOCK HAZARD: To avoid hazard of electrical shock, perform all mounting and wiring of the PowerFlex 527 drives prior to applying power. Once power is applied, connector terminals can have voltage present even when not in use.

Follow these steps to apply power to the PowerFlex 527 system.

1. Disconnect the load to the motor.



ATTENTION: To avoid personal injury or damage to the equipment, disconnect the load to the motor. Make sure each motor is free of all linkages when initially applying power to the system.

2. Apply AC power.

The LCD display begins the startup sequence. See [Startup Sequence on page 44](#) for more information.

3. When the startup sequence completes, verify that the MOD and NET status indicators are steady green.

If the two status indicators are not solid green, see [PowerFlex 527 Drive Status Indicators on page 124](#) for more information.

4. Monitor the DC Bus voltage on the LCD display. See [Real-time Information Display on page 47](#) for more information.

If the DC Bus does not reach the expected voltage level, check the three-phase input power connections. Also it can take as many as 1.8 seconds after input power is applied before the drive can accept motion commands.

5. Verify that the axis state changes to STOPPED.

If the axis state does not change to STOPPED, see [Fault Codes on page 120](#).

Test and Tune the Axes – Velocity and Position Control Modes

This procedure assumes that you have configured your PowerFlex 527 drive, your Logix5000 controller, and applied power to the system.

IMPORTANT Before proceeding with testing and tuning your axes, verify that the MOD and NET status indicators are operating as described in [PowerFlex 527 Drive Status Indicators on page 124](#).

For help using the Logix Designer application as it applies to testing and tuning your axes with ControlLogix EtherNet/IP modules or CompactLogix 5370 controllers, see [Additional Resources on page 7](#).

Test the Axes

Follow these steps to test the axes.

1. Verify the load was removed from each axis.
2. In your Motion Group folder, right-click an axis and choose Properties.

The Axis Properties dialog box appears.

3. Click the Hookup Tests category.

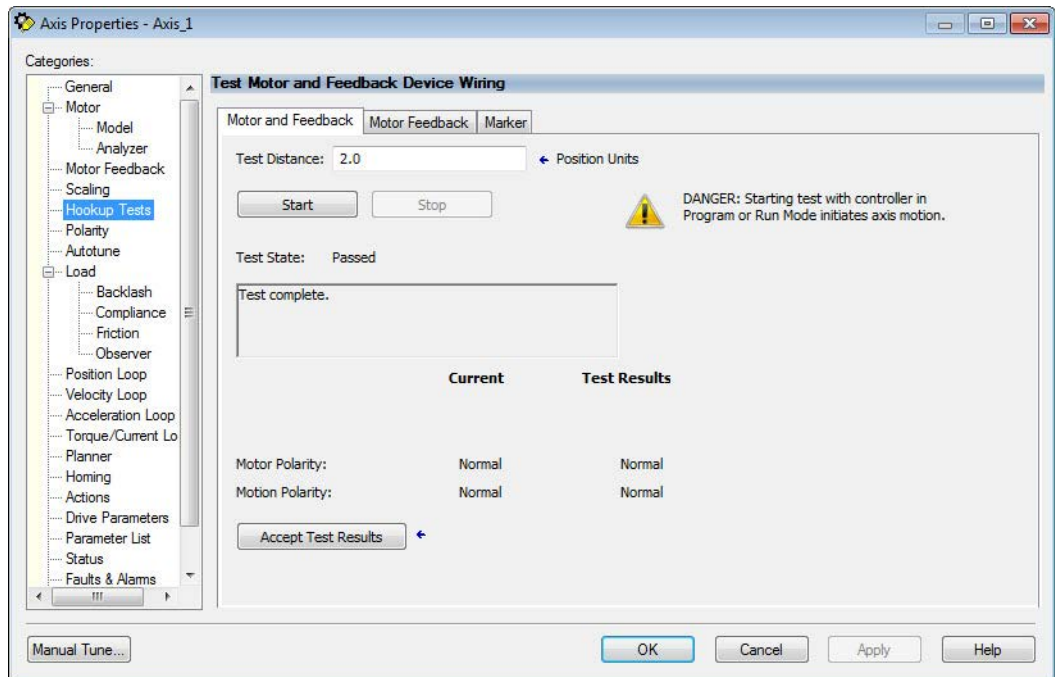

4. In the Test Distance field, type 2.0 as the number of revolutions for the test.

Test	Description
Marker	Verifies marker detection capability as you rotate the motor shaft.
Motor Feedback	Verifies feedback connections are wired correctly as you rotate the motor shaft.
Motor and Feedback	Verifies motor power and feedback connections are wired correctly as you command the motor to rotate.

5. Click the Motor and Feedback tab.

The Marker and Motor Feedback tests are not supported in Frequency Control mode.

6. Click Start.

The Logix Designer - Motor and Feedback Test dialog box appears. The Test State is Executing. TESTING appears on the drive LCD display.

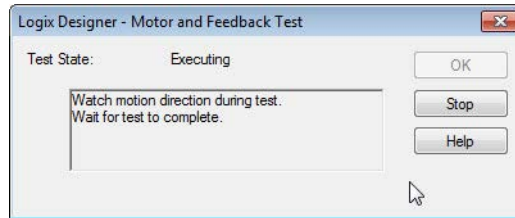

When the test completes successfully, the Test State changes from Executing to Passed.

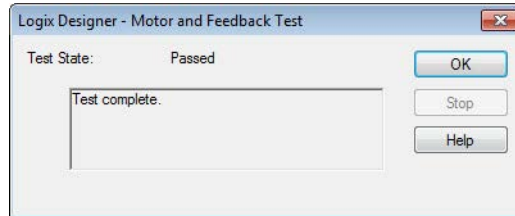

7. Click OK.

This dialog box appears asking if the direction was correct.

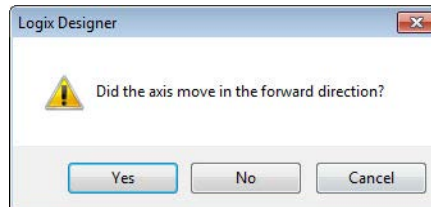

8. Click Yes.
9. Click Accept Test Results.
10. If the test fails, this dialog box appears.

- a. Click OK.
- b. Verify the DC Bus voltage.
- c. Verify unit values entered in the Scaling category.
- d. Return to [step 6](#) and run the test again.

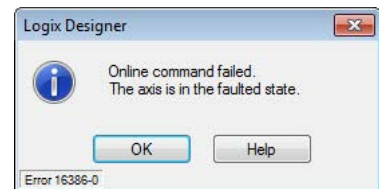

Tune the Axes

Tuning the Axes is not applicable when using the Frequency Control method. Follow these steps to tune the axes.

1. Verify the load is still removed from the axis being tuned.



ATTENTION: To reduce the possibility of unpredictable motor response, tune your motor with the load removed first, then re-attach the load and perform the tuning procedure again to provide an accurate operational response.

2. Click the Autotune category.

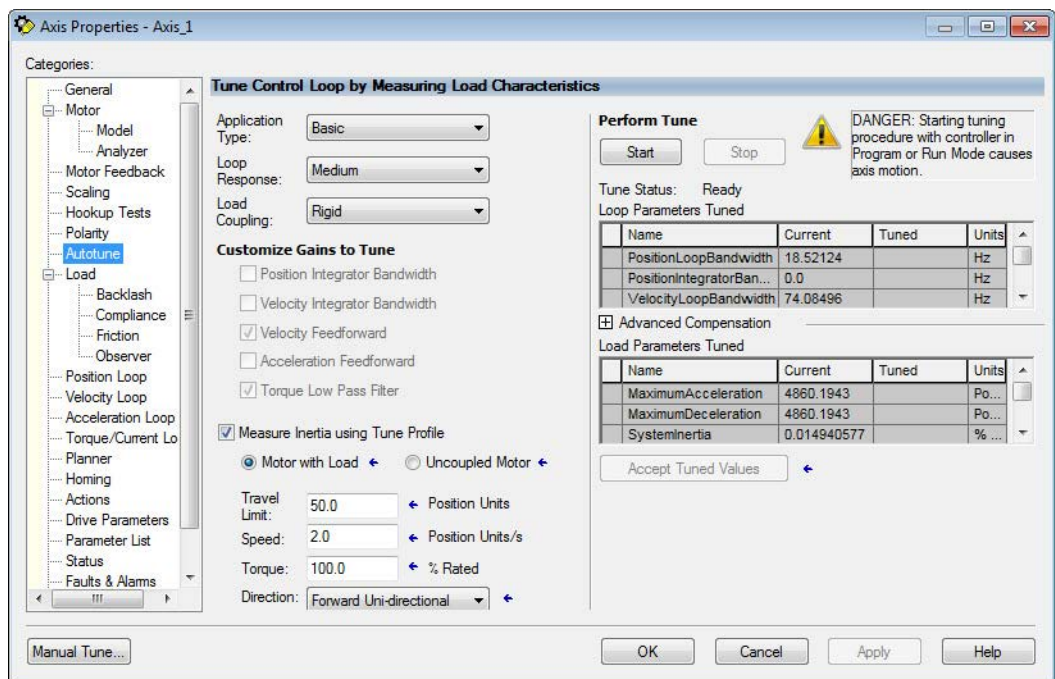

3. Type values for Travel Limit and Speed.

In this example, Travel Limit = 5 and Speed = 10. The actual value of programmed units depending on your application.

4. From the Direction pull-down menu, choose a setting appropriate for your application.

The default setting is Forward Uni-directional.

5. Edit other fields as appropriate for your application.
6. Click Start.

The Logix Designer - Autotune dialog box appears. When the test completes, the Test State changes from Executing to Success.

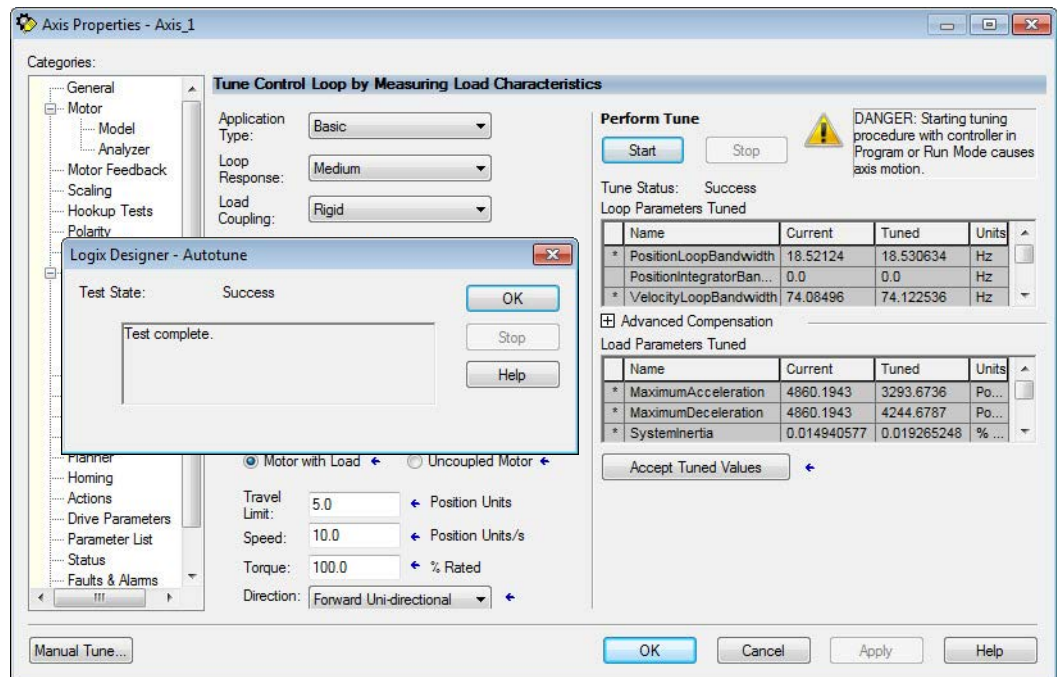

Tuned values populate the Loop and Load parameter tables. Actual bandwidth values (Hz) depend on your application and can require adjustment once motor and load are connected.

7. Click Accept Tuned Values.
8. Click OK to close the Logix Designer - Autotune dialog box.
9. Click OK to close the Axis Properties dialog box.
10. If the test fails, this dialog box appears.
 - a. Click OK.
 - b. Make an adjustment to motor velocity.
 - c. See the Integrated Motion on the Ethernet/IP Network Configuration and Startup User Manual, publication [MOTION-UM003](#) for more information.
 - d. Return to [step 6](#) and run the test again.
11. Repeat Test and Tune the Axes for each axis.

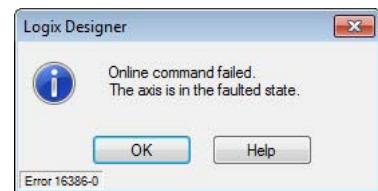

PowerFlex 527 Integrated Safe Torque-Off

This chapter introduces you to how the PowerFlex 527 integrated safe torque-off feature meets the requirements of Performance Level e (PLe), Category 3 according to EN ISO 13849, and SIL CL3 according to IEC 61508, EN 61800-5-2, and EN 62061.

For information on...	See page...
Certification	85
Description of Operation	86
Probability of Dangerous Failure Per Hour (PFH)	87
Safe Torque-Off (STO) Feature	87
Out-of-Box (OOB) Safety State	89
Safe Torque-Off Status	91
Explicit Messages	92

Certification

The TÜV Rheinland group has approved PowerFlex 527 drives with integrated safe torque-off for use in safety-related applications up to PLe, Category 3 according to EN ISO 13849, and SIL CL3 according to IEC 61508, EN 61800-5-2, and EN 62061, in which removing the motion-producing power is considered to be the safe state

See [CE Conformity on page 34](#) for more information regarding certification.

Important Safety Considerations

The system user is responsible for the following:

- Validation of any sensors or actuators connected to the system.
- Completing a machine-level risk assessment.
- Certification of the machine to the desired EN ISO 13849 performance level or EN 62061 SIL level.
- Project management and proof testing performed in accordance with EN ISO 13849.

Category 3 Requirements According to ISO 13849

Safety-related parts are designed with these attributes:

- A single fault in any of these parts does not lead to the loss of the safety function.
- A single fault is detected whenever reasonably practicable.
- Accumulation of undetected faults can lead to the loss of the safety function and a failure to remove motion producing power from the motor.

Stop Category Definition

Stop category 0 as defined in EN 60204 or Safe Torque-Off as defined by EN 61800 5 2 is achieved with immediate removal of motion-producing power to the actuator.

IMPORTANT In the event of a malfunction, the most likely stop category is category 0. When designing the machine application, timing and distance must be considered for a coast to stop. For more information regarding stop categories, refer to EN 60204-1.

Performance Level (PL) and Safety Integrity Level (SIL)

For safety-related control systems, Performance Level (PL), according to EN ISO 13849, and SIL levels, according to EN 61508 and EN 62061, include a rating of the system's ability to perform its safety functions. All of the safety-related components of the control system must be included in both a risk assessment and the determination of the achieved levels.

Refer to the EN ISO 13849, EN 61508, and EN 62061 standards for complete information on requirements for PL and SIL determination.

Description of Operation

The Safe Torque-Off (STO) feature provides a method, with sufficiently low probability of failure, to force the power-transistor control signals to a disabled state. When the command to allow torque ceases, all of the drive output-power transistors are released from the On state. This results in a condition where the motor is coasting (stop category 0). Disabling the power transistor output does not provide mechanical isolation of the electrical output that is required for some applications.

The PowerFlex 527 drive STO function response time is less than 12 ms. Response time is the delay between the time the drive STO function receives the STO request and the time when motion producing power is removed from the motor.

Probability of Dangerous Failure Per Hour (PFH)

Safety-related systems are classified as operating in a High-demand/continuous mode where the frequency of demands for operation made on a safety-related system is greater than once per year.

The SIL value for a High-demand/continuous mode safety-related system is directly related to the probability of a dangerous failure occurring per hour (PFH).

PFH Data

This PFH calculation is based on the equations from EN 61508 and show worst-case values.

Determination of safety parameters is based on the assumptions that the system operates in High-demand mode and that the safety function is requested at least once a year.

This table provides data for a 10-year proof test interval and demonstrates the worst-case effect of various configuration changes on the data.

IMPORTANT Determination of safety parameters is based on the assumptions that the system operates in High-demand mode and that the safety function is requested at least once every three months.

PFH for 10-year Proof Test Interval

Attribute	Value (Hardwired and Network)
PFH (1e-9)	2.10
Proof test (years)	10

Safe Torque-Off (STO) Feature

The safe torque-off circuit, when used with suitable safety components, provides protection according to EN ISO 13849 (PL_e), Category 3 or according to IEC EN 61508, EN 61800-5-2, and EN 62061 (SIL CL3). All components in the system must be chosen and applied correctly to achieve the desired level of operator safeguarding.

The safe torque-off circuit is designed to safely turn off all of the output-power transistors. You can use the safe torque-off circuit in combination with other safety devices to achieve the stop and protection-against-restart as specified in IEC 60204-1.



ATTENTION: This option is suitable only for performing mechanical work on the drive system or affected area of a machine. It does not provide electrical safety.



SHOCK HAZARD: In Safe Torque-Off mode, hazardous voltages can still be present at the drive. To avoid an electric shock hazard, disconnect power to the system and verify that the voltage is zero before performing any work on the drive.

Safe Torque-Off Feature Bypass

PowerFlex 527 drives do not operate without a safety circuit or safety bypass wiring. For applications that do not require the safe torque-off feature, you must install jumper wires to bypass the safe torque-off circuitry.

PowerFlex 527 drives ship with the safety control in the out-of-box state and with a safety bypass jumper in place. In this configuration, the PowerFlex 527 safe torque-off function is disabled.

Safe Torque-Off Bypass Wiring

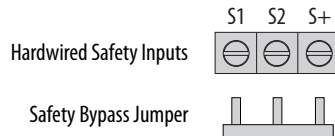

IMPORTANT If safe torque-off is not required, the drive must be returned to the as-shipped safety configuration to allow operation.

IMPORTANT If the Safety Bypass Jumper is misplaced, it is acceptable to wire the S1, S2, and S+ input terminals together.

As-Shipped Safety Configuration

The PowerFlex 527 drive is shipped with:

- Safety control in out-of-box state
- Safety Bypass Jumper installed

In this configuration, the PowerFlex 527 safe torque-off function is disabled.

Out-of-Box (OOB) Safety State

PowerFlex 527 drives ship in the out-of-box safety state.

Recognizing the Out-of-Box State

The safety control state can be read from the axis tag `AxisSafetyState`, or by using a MSG command in Logix Designer software to read the Safety Supervisor Status.

If the state is “Waiting for TUNID” (8) or “Waiting for TUNID with Torque Permitted” (51) then the safety control is in the out-of-box state.

Safety Supervisor State: Values

Value	Definition	Definition	Mode
2	Idle	No active connections	Network
4	Executing	Normal running state	Network
7	Configuring	Transition state	Network
8	Waiting for TUNID	Out-of-Box state	Hardwired
51	Waiting for TUNID with Torque Permitted	Out-of-Box state	Hardwired
52	Executing with Torque Permitted	STO Bypass state	Network

Restoring the Drive to the Out-of-Box State

After the integrated safety connection configuration is applied to the PowerFlex 527 drive at least once, you can follow these steps to restore your PowerFlex 527 drive to the out-of-box state.

1. Right-click the PowerFlex 527 drive you created, and choose Properties.

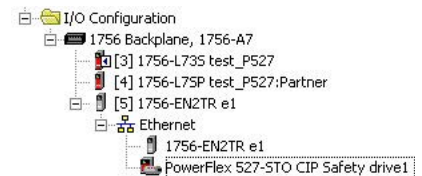

- Click the Connection tab.
The Connection tab appears.

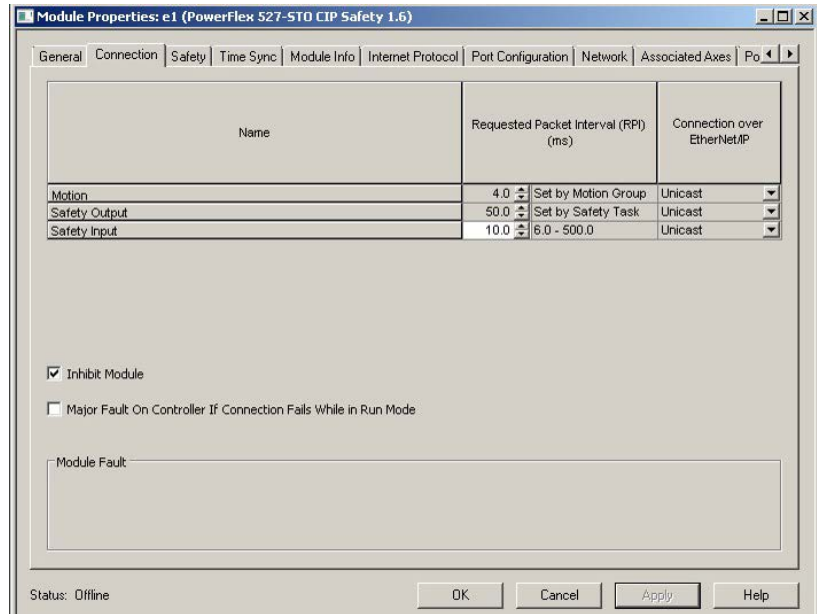

- Check Inhibit Module.
- Click Apply, then click the Safety tab.
The Safety tab appears.

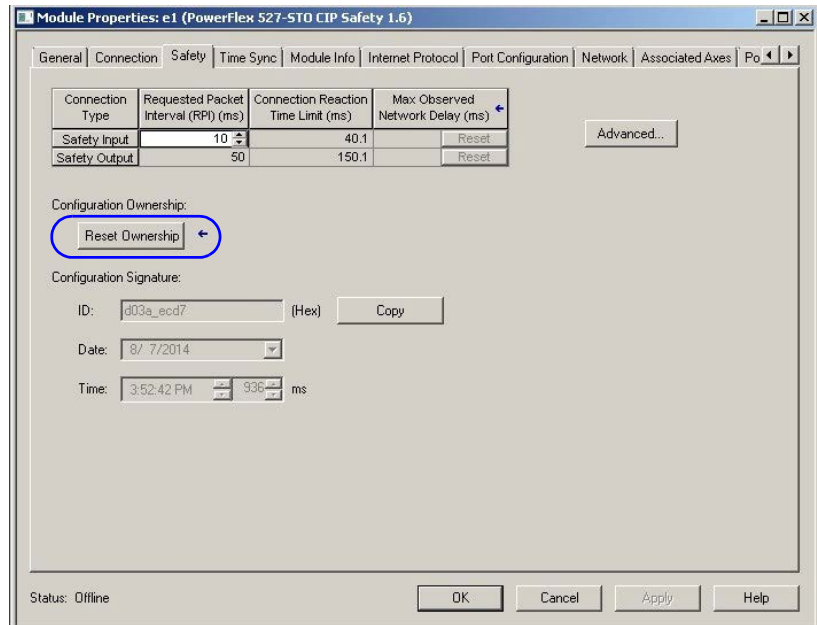

- In the Configuration Ownership field, click Reset Ownership.

IMPORTANT Only authorized personnel should attempt Reset Ownership.

The safety connection must be inhibited before the reset is attempted. If any active connection to the drive is detected, the reset is rejected.

The drive is now in the out-of-box state.

IMPORTANT When the drive returns to the out-of-box state, the STO function reverts to hardwired control.

Safe Torque-Off Status

This section describes the safety-related status that is available to the motion controller.



ATTENTION: The status data described in this section is STANDARD data (not SAFETY data) and may not be used as part of a safety function.

Axis Tags

When a PowerFlex 527 Add-On-Profile (AOP) is added to a Logix I/O tree, Axis tags are added to the controller tags.

[Safety-Related Axis Tags on page 91](#) lists the safety-related STANDARD tags that are added when a new AXIS_CIP_DRIVE axis is defined.

Safety-Related Axis Tags

Logix Designer Tag Name	Attribute [bit]	Type	Description
AxisFault	34	DINT	
GuardFaultStatus	[5]	BOOL	STO Fault - Hardwired
SafetyFaultStatus	[8]	BOOL	STO Fault - Network
GuardStatus ⁽¹⁾	980	DINT	
GuardOKStatus	[0]	BOOL	Not STO Fault - Hardwired
GuardGateDriveOutputStatus	[2]	BOOL	Torque Permitted - Hardwired
GuardStopInputStatus	[3]	BOOL	Safety Inputs Enabled
GuardStopRequestStatus	[4]	BOOL	Torque Disabled - Hardwired
GuardFault ⁽¹⁾	981	DINT	
GuardStopInputFault	[9]	BOOL	STO Fault - Hardwired
GuardGateDriveFault	[2]	BOOL	Internal STO Circuit Fault - Hardwired
CIPAxisFaultsRA	903	LINT	
SafetyModuleCommunicationErrorFault	[28]	BOOL	Loss of communications to Safety Control
CIPAxisAlarmsRA	904	LINT	
SafetyModuleCommunicationErrorAlarm	[28]	BOOL	Loss of communications to Safety Control
CIPInitializationFaultsRA	910	DINT	
InvalidSafetyFirmwareFault	[14]	BOOL	Invalid Safety Control Firmware
CIPStartInhibits	676	INT	
SafeTorqueOffActiveInhibit	[5]	BOOL	Torque Disabled - Network
CIPStartInhibitsRA	912	INT	
SafeTorqueOffInhibit	[5]	BOOL	Torque Disabled - Hardwired
AxisSafetyState	760	INT	Safety Supervisor State

Continued on the next page

(1) Bits not shown are always zero.

Safety-Related Axis Tags (continued)

Logix Designer Tag Name	Attribute [bit]	Type	Description
AxisSafetyStatus ⁽¹⁾	761	DINT	
SafetyFaultStatus	[0]	BOOL	Status of SI.SafetyFault
SafetyResetRequestStatus	[1]	BOOL	Status of SO.ResetRequest
SafetyResetRequiredStatus	[2]	BOOL	Status of SI.ResetRequired
SafeTorqueOffActiveStatus	[3]	BOOL	Status of SO.SafeTorqueOff
SafeTorqueDisabledStatus	[4]	BOOL	Status of SI.TorqueDisabled
SafetyOutputConnectionClosed	[30]	BOOL	1 if all output connections are closed
SafetyOutputConnectionIdleStatus	[31]	BOOL	1 if output controller is in program mode
AxisSafetyFaults ⁽¹⁾	763	DINT	
SafetyCoreFault	[1]	BOOL	Loss of communications to Safety Control
SafeTorqueOffFault	[3]	BOOL	Status of SI.SafetyFault

(1) Bits not shown are always zero.

Explicit Messages

Explicit messages can be used to obtain additional diagnostic information from the safety control using a MSG instruction.

Safety Supervisor State

The Safety Supervisor State provides information on the state of the CIP Safety connection and the mode of operation:

Safety Supervisor State: MSG

Parameter	Value	Description
Service Code	0x0E	Get Attribute Single
Class	0x39	Safety Supervisor
Instance	1	
Attribute	0x0B	Device Status
Data Type	SINT	Unsigned Short Integer

Safety Supervisor State: Values

Value	Definition	Definition	Mode
2	Idle	No active connections	Network
4	Executing	Normal running state	Network
7	Configuring	Transition state	Network
8	Waiting for TUNID	Out-of-Box state	Hardwired
51	Waiting for TUNID with Torque Permitted	Out-of-Box state	Hardwired
52	Executing with Torque Permitted	STO Bypass state	Network

Propose TUNID Blocked

The attribute Propose TUNID Blocked can be used to check if the drive is in a state where it will accept a safety connection. If the drive is enabled, it will not accept a safety connection.

Propose TUNID Blocked: MSG

Parameter	Value	Description
Service Code	0x0E	Get Attribute Single
Class	0x5A	Safety Stop Functions
Instance	0	Class attribute
Attribute	0x65	STO Mode
Data Type	SINT	Unsigned Short Integer

Safe Torque-Off Mode: Values

Value	Definition
0	Accept a safety connection
1	Block a safety connection

Safe Torque-Off Mode

The attribute STO Mode can be used to check if the PowerFlex 527 is in STO Bypass Mode.

Safe Torque-Off Mode: MSG

Parameter	Value	Description
Service Code	0x0E	Get Attribute Single
Class	0x5A	Safety Stop Functions
Instance	1	Axis number
Attribute	0x104	STO Mode
Data Type	SINT	Unsigned Short Integer

Safe Torque-Off Mode: Values

Value	Definition
1	Normal Operation
2	STO Bypass Mode

Safe Torque-Off Faults

When a safety fault is indicated in any of the following tags:

- SI.SafetyFault
- Axis.SafetyFaultStatus
- Axis.SafetyTorqueOffFault

The cause of the fault can be read using an explicit message:

Safe Torque-Off Fault Type: MSG

Parameter	Value	Description
Service Code	0x0E	Get Attribute Single
Class	0x5A	Safety Stop Functions
Instance	1	Axis number
Attribute	0x108	STO Fault Type
Data Type	SINT	Unsigned Short Integer

Safe Torque-Off Fault Type: Values

Value	Definition
1	No Fault
3	Circuit Error
102	Hardwired Input Discrepancy
104	Hardwired Input in Network Mode

Hardwired Control of Safe Torque-Off

This chapter introduces you to how the PowerFlex 527 integrated safe torque-off feature is configured for hardwired control of safe torque-off.

For information on...	See page...
Description of Operation	95
Safe Torque-Off Connector Data	98
Wire the Safe Torque-Off Circuit	98
Safe Torque-Off Specifications	99

Description of Operation

The safe torque-off feature provides a method, with sufficiently low probability of failure, to force the power-transistor control signals to a disabled state. If either hardwired safety input is de-energized, all of the drive output-power transistors are released from the On state. This results in a condition where the drive is coasting (stop category 0). Disabling the power transistor output does not provide mechanical isolation of the electrical output that is required for some applications.

Selection of Hardwired Safe Torque-Off

To select hardwired control of safe torque-off (STO):

- The safety control must be in the out-of-box state.
- The Safety Bypass Jumper must be removed.
- An appropriate safety device must be connected to terminals S1, S2, and 01 (Digital Common).

Operation of Hardwired Safe Torque-Off

Under normal operation, the safe torque-off inputs are energized. If either of the safety enable inputs are de-energized, then all of the output power transistors turn off. The safe torque-off response time is less than 12 ms.



ATTENTION: If any of the safety enable inputs de-energize, the Start Inhibit field indicates SafeTorqueOffInhibit and the GuardStopRequestStatus bit of the AxisGuardStatus tag are set to 1. Both inputs must be de-energized within 1 second and re-energized within 1 second to avoid GuardStopInputFault conditions.

System Operation when Inputs are Meeting Timing Requirements

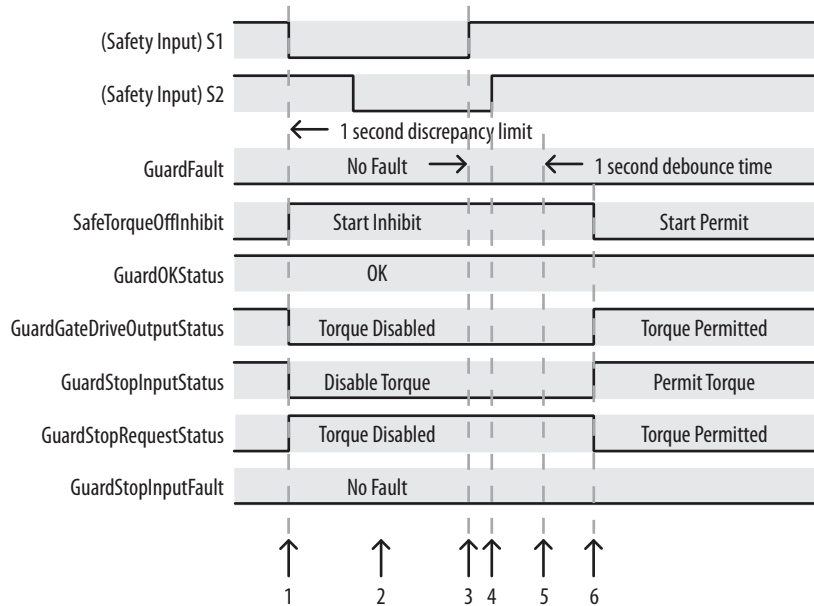

Event	Description
1	At least one input is switched off. GuardStopRequestStatus bit is set to 1.
2	Second input is switched off within 1 second. This must always occur within 1 second to prevent a GuardStopInputFault condition.
3	First input is switched on.
4	Second input is switched on within 1 second of event 3.
5	Both inputs are in the ON state simultaneously within 1 second. As a result, the GuardStopInputFault is not posted.
6	The GuardStopRequestStatus bit sets back to 0 if event 4 occurs within a 100 ms interval after event 3. If event 4 is outside of the 100 ms interval, but within the 1 second interval after event 3, then the GuardStopRequestStatus bit sets back to 0 after the 1 second interval following event 3 (not immediately following event 4).

Troubleshoot the Safe Torque-Off Function

PowerFlex 527 Drive Troubleshooting

Exception Code on Drive Display	Fault Message Logix Designer	Problem	Possible Solutions
SAFE FLT 09 - SS IN	GuardStopInputFault	Safe torque-off function mismatch. System does not allow motion. Safe torque-off mismatch is detected when safety inputs are in a different state for more than 1.0 second.	<ul style="list-style-type: none"> Verify safety wiring and connections: <ul style="list-style-type: none"> Wire terminations at safe torque-off (STO) connector Cable/header not seated correctly +24V power Check state of safety inputs. Reset error and run proof test. Return drive for repair if fault continues.
SAFE FLT S01 - SAFETY CORE INTERNAL	CPUWatchdogFault ⁽¹⁾	Drive safety diagnostic detected internal STO design failure.	<ul style="list-style-type: none"> Cycle power. Return drive for repair if fault continues.
SAFE FLT S03 - SAFE TORQUE OFF	SafeTorqueOffFault ⁽²⁾	Drive safety diagnostic detected internal STO design failure.	<ul style="list-style-type: none"> Cycle power. Execute STO function. Return drive for repair if fault continues.

(1) Displayed in the LCD display as Module Fault.

(2) Displayed in the LCD display as Safety Fault.

[System Operation in the Event that the Safety Enable Inputs Mismatch on page 97](#) demonstrates when the safe torque-off mismatch is detected and a GuardStopInputFault is posted.

System Operation in the Event that the Safety Enable Inputs Mismatch

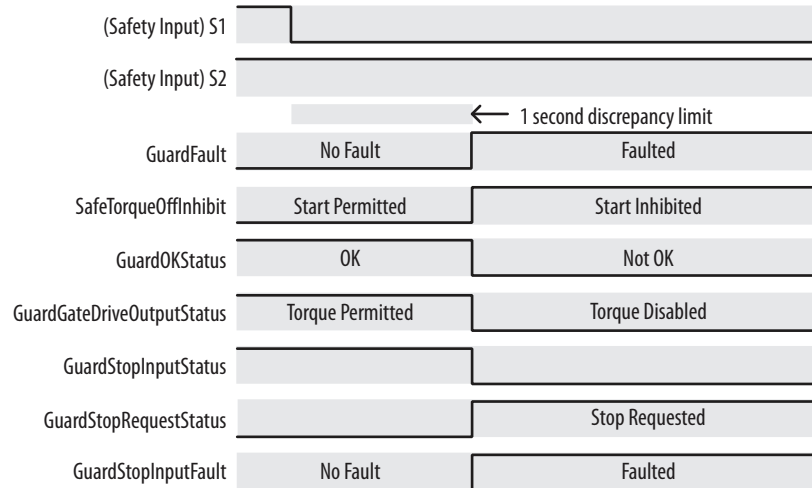

When one safety input is turned off, the second input must also be turned off, otherwise a fault is asserted (see [System Operation in the Event that the Safety Enable Inputs Mismatch Momentarily on page 97](#)). The fault is asserted even if the first safety input is turned on again.

System Operation in the Event that the Safety Enable Inputs Mismatch Momentarily

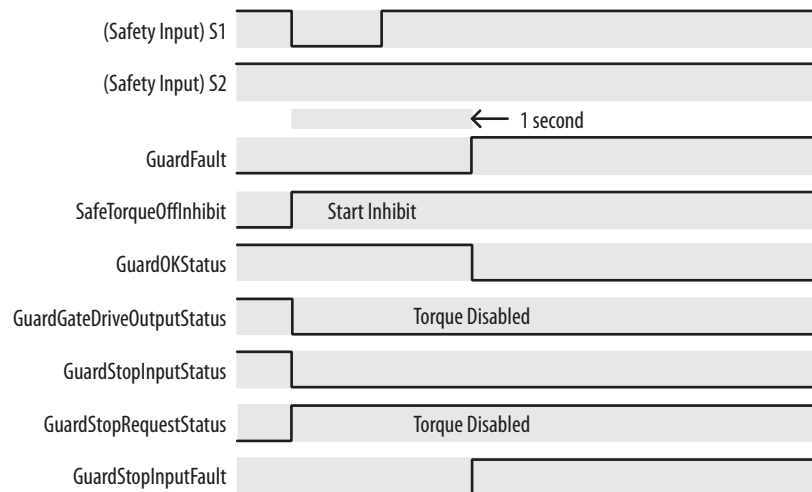

ATTENTION: The safe torque-off fault is detected upon demand of the safe torque-off function. After troubleshooting, a safety function must be executed to verify correct operation.

IMPORTANT The Safe Torque-Off fault can be reset only if both inputs are in the Off state for more than 1 second. After the fault reset requirement is satisfied, an MASR command in the Logix Designer application must be issued to reset the GuardFault and GuardStopInputFault conditions.

Safe Torque-Off Connector Data

PowerFlex 527 terminals S1, S2, and 01 are used for hardwired control of safe torque-off.

Terminals for Safe Torque-Off (STO) Connection

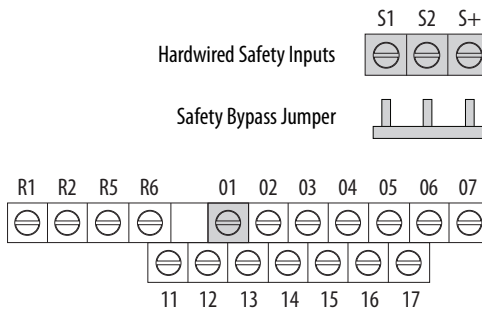

Safe Torque-Off (STO) Connector Pinouts control

STO Pin	Signal	Description
01	Digital Common	The return for digital I/O. It is electrically isolated (along with the digital inputs and encoder power) from the rest of the drive.
S1	Safety 1	Safety input 1.
S2	Safety 2	Safety input 2.
S+	Safety +24V	+24V supply for safety circuit. This is internally tied to the +24V DC source (terminal 11).

IMPORTANT Digital Common (terminal 01) is common for the digital inputs, the safety inputs, and the encoder power supply (optional).

Wire the Safe Torque-Off Circuit

This section provides guidelines for wiring safe torque-off connections to your PowerFlex 527 drive.

IMPORTANT The National Electrical Code and local electrical codes take precedence over the values and methods provided.

IMPORTANT Pin S+ (Safety +24V) is used to disable the safe torque-off function. When wiring to the STO connector, use an external 24V supply for the external safety device that triggers the safe torque-off request. To avoid jeopardizing system performance, do not use pin S+ as a power supply for the external safety device.

Safe Torque-Off Wiring Requirements

The safe torque-off (STO) connection wire must be copper with 75 °C (167 °F) minimum rating.

IMPORTANT The National Electrical Code and local electrical codes take precedence over the values and methods provided.

IMPORTANT Stranded wires must terminate with ferrules to prevent short circuits, per table D.7 of EN ISO 13849-2.

Safe Torque-Off (STO) Terminal Wiring

Maximum Wire Size ⁽¹⁾	Minimum Wire Size ⁽¹⁾	Torque
1.3 mm ² (16 AWG)	0.13 mm ² (26 AWG)	0.71...0.86 Nm (6.2...7.6 lb-in.)

(1) Maximum and minimum sizes that the terminal block will accept. These are not recommended wire sizes.

Safe Torque-Off Specifications

To maintain their safety rating, PowerFlex 527 drives must be installed inside protected control panels or cabinets appropriate for the environmental conditions of the industrial location. The protection class of the panel or cabinet must be IP54 or higher.

Safe Torque-Off Signal Specifications

Attribute	Value	
Safety inputs (per channel)	Input current	< 10 mA
	Input ON voltage, max	18...26.4V DC
	Input OFF voltage, max	5V DC
	Input ON current	10 mA
	Input OFF current	500 μ A
	Pulse rejection width	700 μ s
	External power supply	SELV/PELV
	Input type	Optically isolated and reverse voltage protected

Notes:

Network Control of Safe Torque-Off

This chapter describes network control of the safe torque-off function. With network control, a 1756-L7xS GuardLogix safety controller issues the safe torque-off (STO) command over the EtherNet/IP network and the PowerFlex 527 drive executes the STO command.

For information on...	See page...
Understanding Integrated Safety Drive Replacement	105
Replacing an Integrated Safety Drive in a GuardLogix System	105
Motion Direct Commands in Motion Control Systems	112
Functional Safety Considerations	118

Compatible Safety Controllers

The Studio 5000 Logix Designer application, version 24.00 or later, provides support for programming, commissioning, and maintaining the 1756-L7xS GuardLogix safety controller.

A 1756-L7xS GuardLogix safety controller is required for network control of the PowerFlex 527 safe torque-off function.

The PowerFlex 527 safety connection can originate from a safety controller that provides both safety and motion control.

The PowerFlex 527 safety connection can originate from a safety controller that controls only the safety, while a separate Logix processor controls motion.

Selection of Network Safe Torque-Off

To select network control of safe torque-off:

1. The PowerFlex 527 drive must be added to a 1756-EN2T, 1756-EN2TR, 1756-EN2F, 1756-EN3T, or 1756-EN3TR EtherNet/IP bridge in a 1756-L7xS GuardLogix controller's I/O tree.
2. The 1756-EN2T, 1756-EN2TR, 1756-EN2F, 1756-EN3T, or 1756-EN3TR EtherNet/IP bridge must be configured for “Safety Only” or “Motion and Safety”.
3. Download the new configuration to the controller.
The drive display may show fault code “SAFE FLT S03 - SAFE TORQUE OFF”.

4. Turn off incoming power to the drive.
5. Remove the Safety Bypass jumper.
6. Turn on incoming power to the drive.
Any display fault should now be cleared.

Safety Application Requirements

Creating, recording, and verifying the safety signature is also a required part of the safety application development process. Safety signatures are created by the safety controller. The safety signature consists of an identification number, date, and time that uniquely identifies the safety portion of a project. This signature covers all safety logic, data, and safety I/O configuration.

For safety system requirements, including information on the safety network number (SNN), verifying the safety signature, and functional verification tests refer to the GuardLogix 5570 Controller Systems Safety Reference Manual, publication [1756-RM099](#).

IMPORTANT You must read, understand, and fulfill the requirements detailed in this publication prior to operating a safety system that uses a GuardLogix controller and PowerFlex 527 drive.

Network Safe Torque-off Specifications

Safe Torque-off Network Specifications

Attribute	Value
Safety connection RPI, minimum	6 ms
Input assembly connections	3
Output assembly connections	1
Integrated safety open request support	Type 1 and Type 2 requests

Safe Torque-off Assembly Tags

With network control, a 1756-L7xS GuardLogix safety controller controls the PowerFlex STO function through the SO.SafeTorqueOff tag in the safety output assembly.

The SO.Command tags are sent from the GuardLogix's safety output assembly to the PowerFlex 527 to control the safe torque-off function.

The SI.Status tags are sent from the PowerFlex 527 to the GuardLogix safety input assembly and indicate the status of the PowerFlex 527's safety control.

The SI.ConnectionStatus tags indicate the status of the safety input connection.

[Safe Torque-off Assembly Tags on page 103](#) lists the SAFETY tags added to the controller tags when a PowerFlex 527 drive is added to a GuardLogix I/O configuration and the connection is configured for “Motion and Safety” or for “Safety only”.

The “Attribute” values listed are the Assembly Object attribute values.

Safe Torque-off Assembly Tags

Logix Designer Tag Name	Attribute [bit]	Type	Description
SI.ConnectionStatus ^{(1),(2)}		DINT	
SI.RunMode	[0]	BOOL	See Table 10 - Safety Connection Status in GuardLogix Safety Reference Manual, publication 1756-RM099
SI.ConnectionFaulted	[1]	BOOL	
SI.Status ^{(1),(3)}	0x1A0	SINT	
SI.TorqueDisabled	[0]	BOOL	0 = Torque Permitted; 1 = Torque Disabled
SI.SafetyFault	[6]	BOOL	1 = STO Fault present
SI.ResetRequired	[7]	BOOL	1 = A reset is required
SO.Command ^{(1),(4)}	0x180	SINT	
SO.SafeTorqueOff	[0]	BOOL	0 = Disable Permit; 1 = Permit Torque
SO.Reset	[7]	BOOL	0→1 = Reset STO Fault

(1) Bits not listed are always zero.

(2) ConnectionStatus is determined by the Safety Validator in the GuardLogix controller.

(3) The Status is sent from the drive to the controller using the CIP Safety protocol.

(4) The Command is sent from the controller to the drive using the CIP Safety protocol.



ATTENTION: Only data listed in [Safe Torque-off Assembly Tags on page 103](#) is SAFETY data with SIL 3 integrity.

STO Fault Reset

If a PowerFlex 527 drive safety control detects a fault, the input assembly tag SI.SafetyFault is set to 1. A transition from logic 0 to 1 of the SO.Reset tag is required after the SO.SafeTorqueOff tag has transitioned from logic 0 to 1.

To reset Axis.SafetyFault, a MAFR command must be issued.

IMPORTANT Transition of the SO.SafeTorqueOff tag to logic 1 must always be executed prior to transition of the SO.Reset tag to logic 1.

IMPORTANT PowerFlex 527 drives enter the STO Fault state if any STO function fault is detected. Refer to [PowerFlex 527 Drive Troubleshooting on page 104](#) for integrated safety troubleshooting.

IMPORTANT An STO Fault sets the Axis.SafetyFault tag. After the STO Fault is reset, a MAFR command must be issued by the motion controller to clear the Axis.SafetyFault tag to enable motion.

See [Reset Safe Torque-Off Fault Diagram on page 104](#) for an understanding of the PowerFlex 527 STO Fault reset functionality.

Reset Safe Torque-Off Fault Diagram

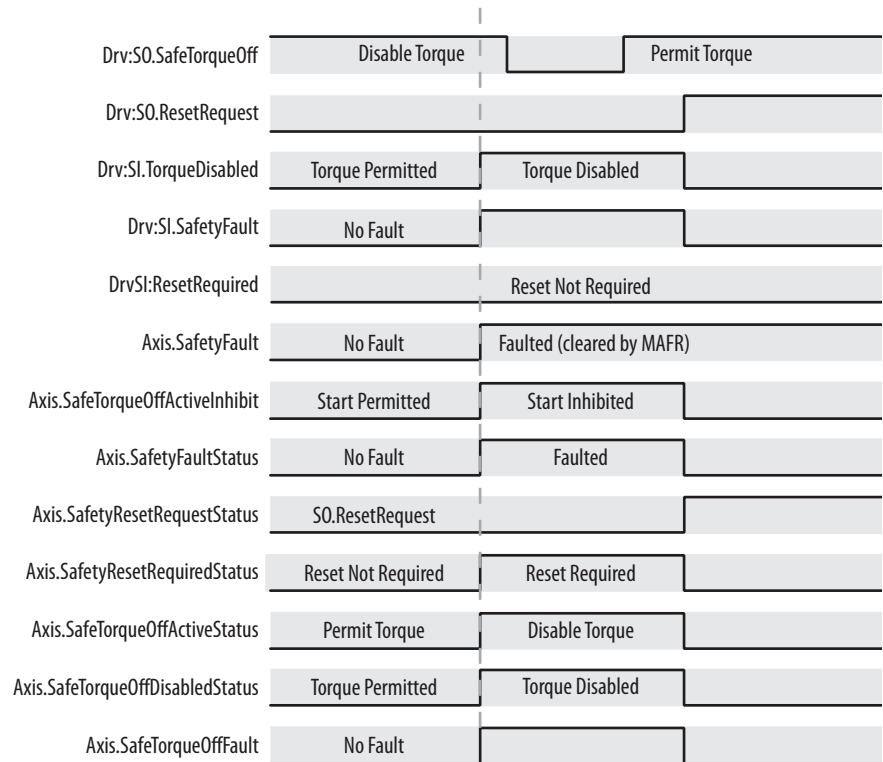

Troubleshoot Network Safe Torque-Off

PowerFlex 527 Drive Troubleshooting

Exception Code on Drive Display	Fault Message Logix Designer	Problem	Possible Solutions
SAFE FLT S01 - SAFETY CORE INTERNAL	CPUWatchDogFault ⁽¹⁾	Drive safety diagnostic detected internal STO design failure.	<ul style="list-style-type: none"> • Cycle power. • Return drive for repair if fault continues.
FLT AXIS FLT M28 - SAFETY COMM	SafetyModuleCommunicationErrorFault ⁽¹⁾	Drive safety diagnostic detected internal STO design failure.	<ul style="list-style-type: none"> • Cycle power. • Return drive for repair if fault continues.
SAFE FLT S03 - SAFE TORQUE OFF (STO Fault Type = 3)	SafeTorqueOffFault ⁽²⁾	Drive safety diagnostic detected internal STO design failure	<ul style="list-style-type: none"> • Cycle power. • Execute STO function. • Return drive for repair if fault continues.
SAFE FLT S03 - SAFE TORQUE OFF (STO Fault Type = 104)	SafeTorqueOffFault ⁽²⁾	Hardwired input energized in network mode.	<ul style="list-style-type: none"> • Remove power. • Remove any connection to hardwired safety inputs. • Restore power.
INIT FLT M14 - INVALID SAFETY FIRMWARE	InvalidSafetyFirmwareFault ⁽²⁾	The safety firmware is not compatible with the drive firmware, or the main safety firmware is missing.	<ul style="list-style-type: none"> • Cycle power. • Upgrade drive firmware. • Return drive for repair if fault continues.

(1) Displayed in the LCD display as Module Fault.
 (2) Displayed in the LCD display as Safety Fault.

Understanding Integrated Safety Drive Replacement

GuardLogix controllers retain I/O device configuration on-board and are able to download the configuration to the replacement device.

IMPORTANT If the replacement PowerFlex 527 drive was used previously, clear its existing configuration before installing it on a safety network by resetting the drive to its out-of-box condition. To see how this is done, refer to [Out-of-Box \(OOB\) Safety State on page 89](#).

Replacing a PowerFlex 527 drive that sits on an integrated safety network is more complicated than replacing standard devices because of the Safety Network Number (SNN). The device number and SNN make up the safety device's DeviceID. Safety devices require this more complex identifier to make sure that duplicate device numbers do not compromise communication between the correct safety devices. The SNN is also used to provide integrity on the initial download to the PowerFlex 527 drive.

When the Logix Designer application is online, the Safety tab of the Module Properties dialog box displays the current configuration ownership. When the opened project owns the configuration, Local is displayed.

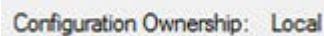

Configuration Ownership: Local

A communication error is displayed if the module read fails. Refer to [Replacing an Integrated Safety Drive in a GuardLogix System on page 105](#) for integrated safety drive replacement examples.

Replacing an Integrated Safety Drive in a GuardLogix System

If you are relying on a portion of the integrated safety system to maintain SIL 3 behavior during drive replacement and functional testing, do not use the Configure Always feature.

Use the Configure Always feature when you are not relying on the entire routable integrated safety control system to maintain PLe/SIL 3 behavior during the replacement and functional testing of a PowerFlex 527 drive. Drive replacement is configured on the Safety tab of the GuardLogix controller.

Setting the SNN with a GuardLogix Controller

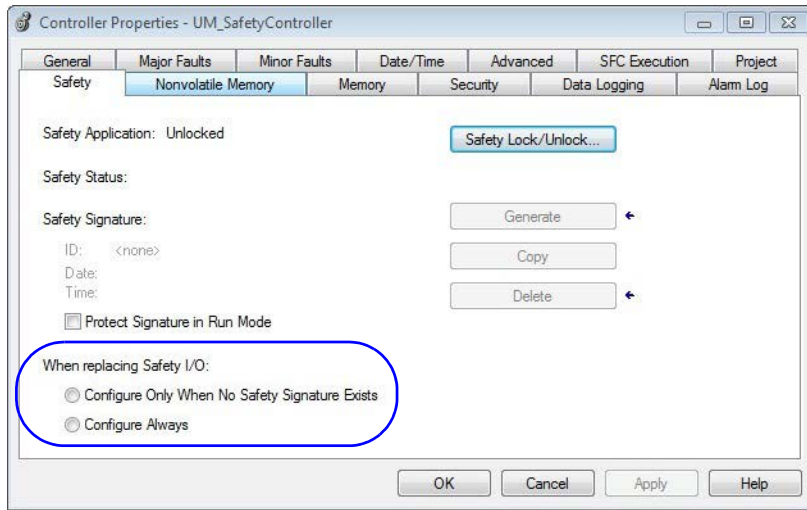

Replacement with “Configure Only When No Safety Signature Exists” Enabled

When a PowerFlex 527 drive is replaced and the DeviceID of the new drive matches the original, you can download the configuration from the safety controller. The DeviceID is a combination of the node/IP address and the safety network number (SNN), and is updated whenever the SNN is set.

If the project is configured as Configure Only When No Safety Signature Exists, follow the appropriate instructions in [Replacing a PowerFlex 527 Drive on page 106](#) to replace a PowerFlex 527 drive based on your scenario. Once you have completed the steps correctly and the DeviceID matches the original, the safety controller can download the proper drive configuration and re-establish the safety connection.

Replacing a PowerFlex 527 Drive

GuardLogix Safety Signature Exists	GuardLogix Safety Signature Exists	Action Required
No	No SNN (out-of-box)	None. The module is ready for use.
Yes or No	Same SNN as original safety task configuration	
Yes	No SNN (out-of-box)	Refer to Scenario 1 on page 107 .
Yes	Different SNN than original safety task configuration	Refer to Scenario 2 on page 108 .
No		Refer to Scenario 3 on page 110 .

Scenario 1 – Replacement Integrated Safety Drive Is Out-of-Box and Safety Signature Exists

1. Remove and replace the existing integrated safety drive.
2. Right-click the replacement drive and choose Properties.
The General tab appears in the Module Properties dialog box.

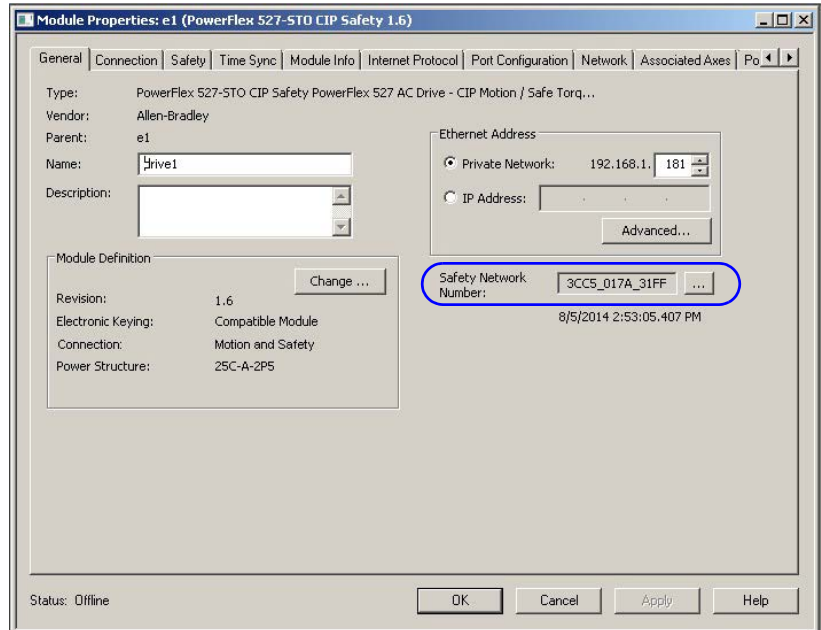

3. Click **...** to the right of the Safety Network Number (SNN).
The Safety Network Number dialog box appears.

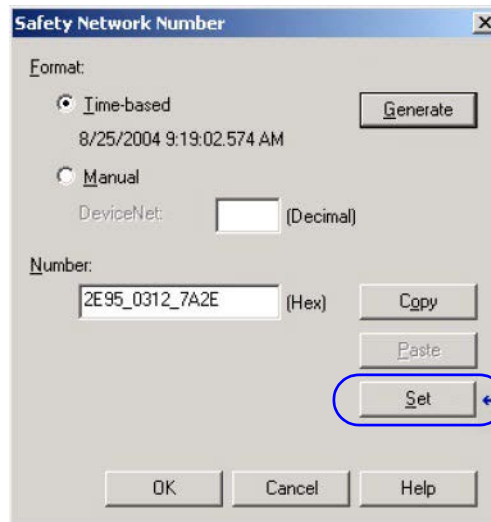

4. Click Set.

5. Verify that the Network Status (NET) status indicator is alternating red/green on the correct drive.

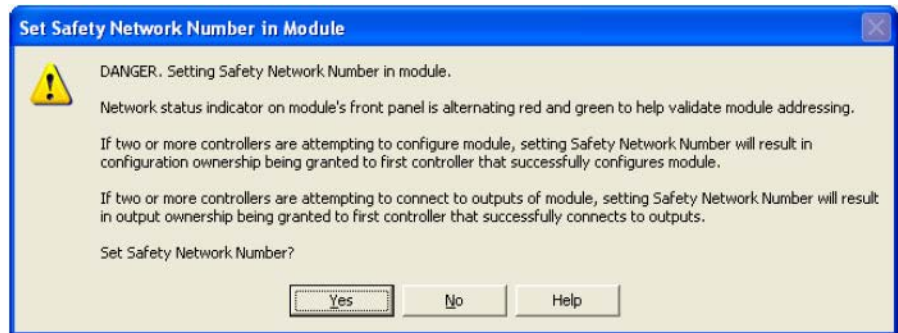

6. Click Yes to set the SNN and accept the replacement drive.
7. Power cycle the drive.
8. Follow your company-prescribed procedures to functionally test the replacement drive and system and to authorize the system for use.

Scenario 2 – Replacement Integrated Safety Drive SNN is Different from Original and Safety Signature Exists

1. Remove and replace the existing integrated safety drive.
2. Right-click the replacement drive and choose Properties.
3. Click the Safety tab.

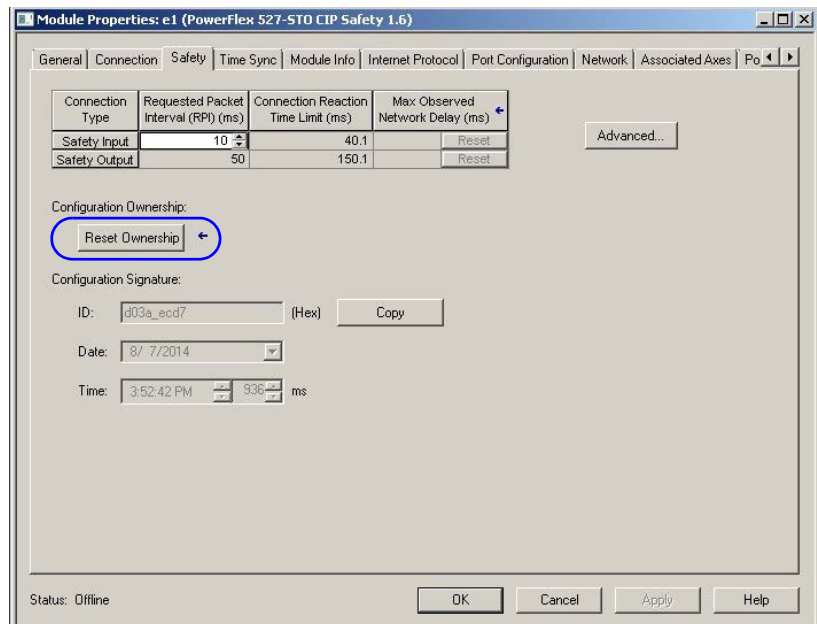

4. Click Reset Ownership.
5. Click OK.

- Right-click the replacement drive and chooses Properties. The General tab appears in the Module Properties dialog box.

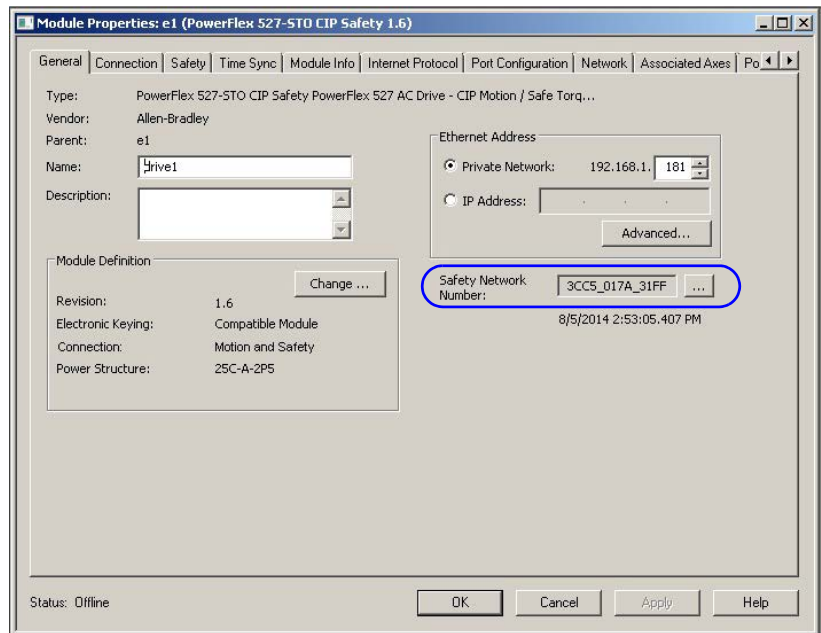

- Click  to the right of the Safety Network Number (SNN). The Safety Network Number dialog box appears.

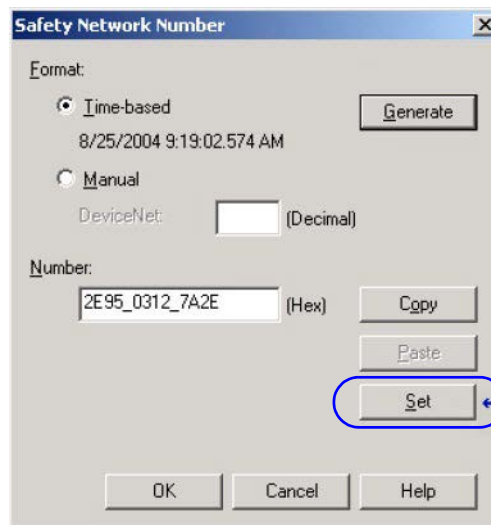

- Click Set.

9. Verify that the Network Status (NET) status indicator is alternating red/green on the correct drive.

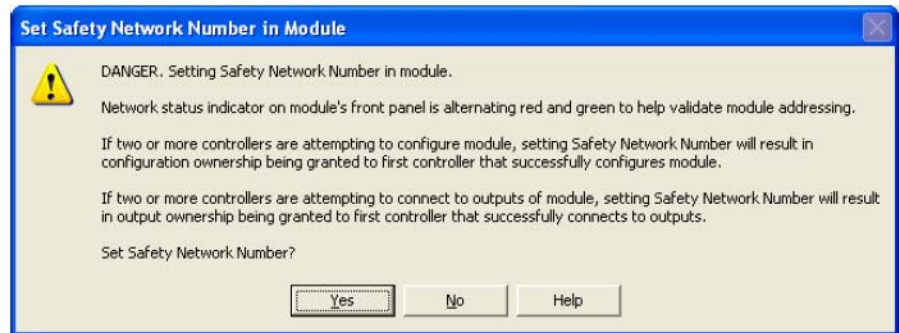

10. Power cycle the drive.
11. Follow your company-prescribed procedures to functionally test the replacement drive and system and to authorize the system for use.

Scenario 3 – Replacement Integrated Safety Drive SNN is Different from Original and no Safety Signature Exists

1. Remove and replace the existing integrated safety drive.
2. Right-click the replacement drive and choose Properties.
3. Click the Safety tab.

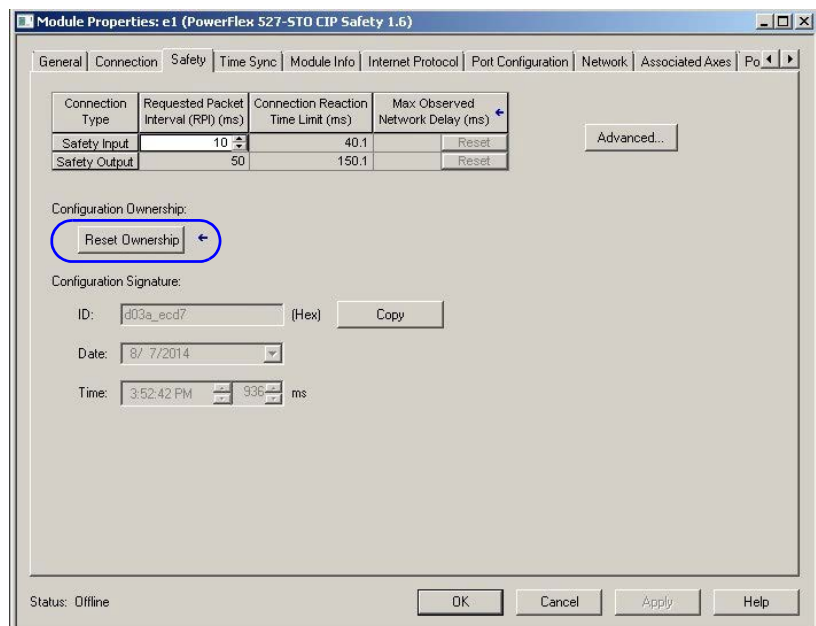

4. Click Reset Ownership.
5. Click OK.
6. Power cycle the drive.
7. Follow your company-prescribed procedures to functionally test the replacement drive and system and to authorize the system for use.

Replacement with “Configure Always” Enabled



ATTENTION: Enable the Configure Always feature only if the entire integrated safety control system is not being relied on to maintain SIL 3 behavior during the replacement and functional testing of a PowerFlex 527 drive. Do not place drives that are in the Out-of-box condition on an integrated safety network when the Configure Always feature is enabled, except while following this replacement procedure.

When the Configure Always feature is enabled, the controller automatically checks for and connects to a replacement drive that meets all of the following requirements:

- The controller has configuration data for a compatible drive at that network address.
- The drive is in the Out-of-box condition or has an SNN that matches the configuration.

If the project is configured for Configure Always, follow the appropriate steps to replace a PowerFlex 527 drive.

Follow these steps when the Configure Always feature is enabled.

1. Remove and replace the existing integrated safety drive.

If	Then
The drive is in the Out-of-box condition	Go to step 6. No action is needed for the GuardLogix controller to take ownership of the drive.
An SNN mismatch error occurs	Go to the next step to reset the drive to the Out-of-box condition.

2. Right-click the replacement drive and choose Properties.

3. Click the Safety tab.

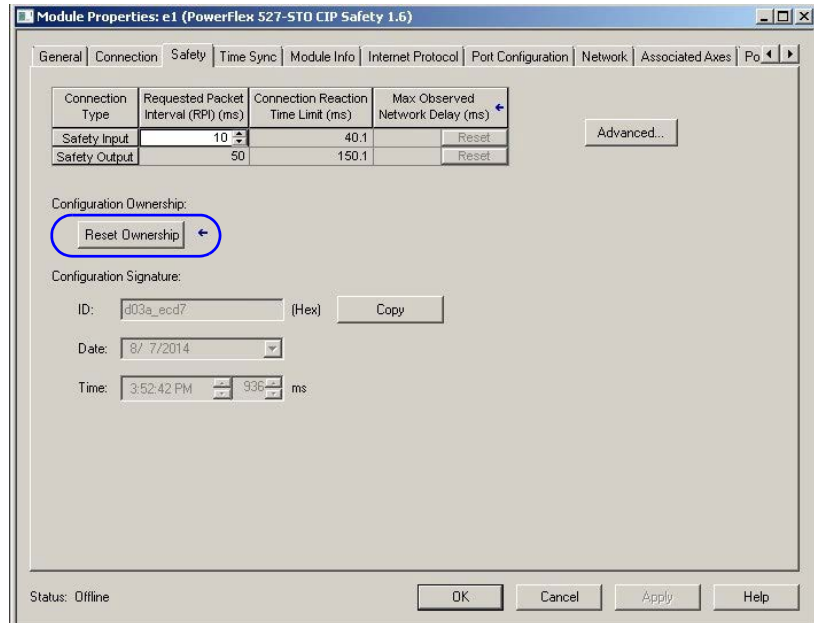

4. Click Reset Ownership.

5. Click OK.

6. Follow your company-prescribed procedures to functionally test the replacement drive and system and to authorize the system for use.

Motion Direct Commands in Motion Control Systems

You can use the Motion Direct Command (MDC) feature to initiate motion while the controller is in Program mode, independent of application code that is executed in Run mode. These commands let you perform a variety of functions, for example, move an axis, jog an axis, or home an axis. See the Logix5000 Motion Controllers Instructions Reference Manual, publication [MOTION-RM002](#) for more information.

A typical use might involve a machine integrator testing different parts of the motion system while the machine is being commissioned, or a maintenance engineer, under certain restricted scenarios in accordance with safe machine operating procedures, wanting to move an axis (like a conveyor) to clear a jam before resuming normal operation.



ATTENTION: To avoid personal injury or damage to equipment, follow these rules regarding Run mode and Program mode.

- Only authorized, trained personnel with knowledge of safe machine operation should be allowed to use Motion Direct Commands.
- Additional supervisory methods, like removing the controller key switch, should be used to maintain the safety integrity of the system after returning the safety controller to RUN mode.

Understanding STO Bypass When Using Motion Direct Commands

If a Safety-only connection between the GuardLogix safety controller and the PowerFlex 527 drive was established at least once after the drive was received from the factory, the drive does not allow motion while the safety controller is in Program mode by default.

This is because the safety task is not executed while the GuardLogix safety controller is in Program mode. This applies to applications running in a single safety controller (with Motion and Safety connections). When an integrated safety drive has a Motion connection to a standard controller and a separate Safety connection to a dual-safety controller, the standard controller can transition to Program mode while the safety controller stays in Run mode and continues to execute the safety task.

However, PowerFlex 527 drive systems are designed with a bypass feature for the STO function in single-safety controller configurations. You can use the MDC feature to allow motion while following all the necessary and prescribed steps per your machine's safety operating procedures.



ATTENTION: Consider the consequences of allowing motion through the use of MDC when the controller is in Program mode. You must acknowledge warning messages in the Logix Designer application that warn of the drive bypassing the STO function and unintended motion can occur. The integrated safety drive does not respond to requests of the STO function if MDC mode is entered.

ATTENTION: It is your responsibility to maintain machine safety integrity while executing motion direct commands. One alternative is to provide ladder logic for Machine Maintenance mode that leaves the controller in Run mode with safety functions executing.

Logix Designer Application Warning Messages

When the controller is in Run mode, executing safety functions, the PowerFlex 527 drive follows the commands that it receives from the safety controller. The controller will report Safety state = Running and Axis state = Stopped/Running, as shown in [Safety State Indications When Controller is in Run Mode \(safety task executing\) on page 114](#).

Safety State Indications When Controller is in Run Mode (safety task executing)

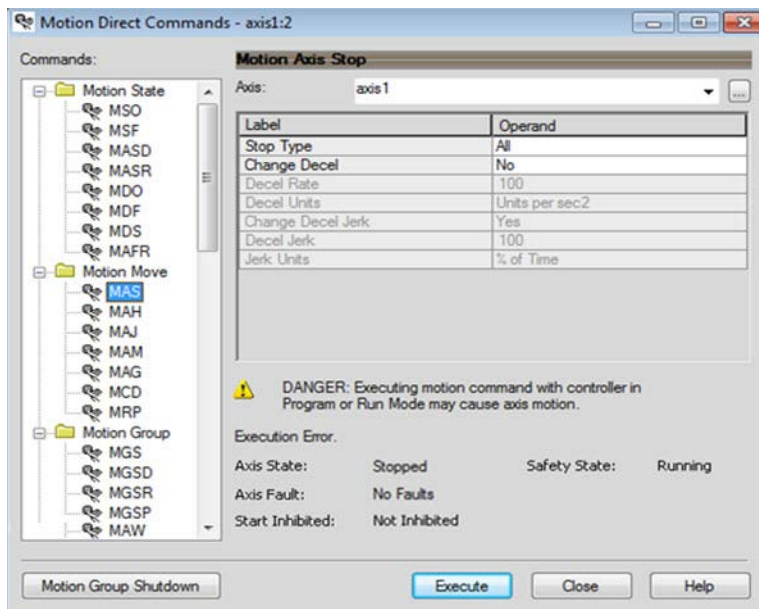

When the controller transitions to Program mode, the integrated safety drive is in the safe state and torque is not permitted. The controller will report Safety state = Not Running and Axis state = Start Inhibited, as shown in [Safety State Indications After Controller Transitions to Program Mode on page 114](#).

Safety State Indications After Controller Transitions to Program Mode

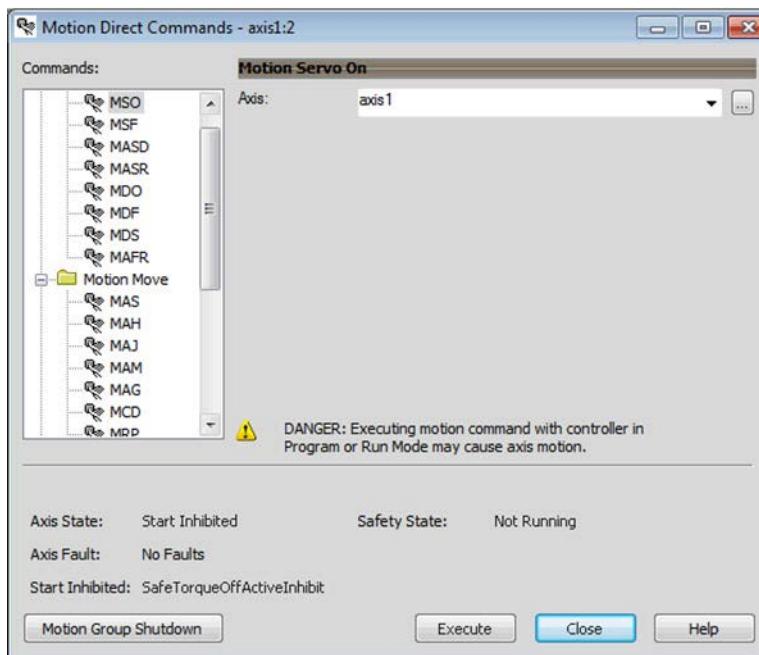

When you issue a motion direct command to an axis to produce torque in Program mode, for example MSO or MDS, with the safety connection present to the drive, a warning message is presented before the motion direct command is executed, as shown in [STO Bypass Prompt When the Safety Controller is in Program Mode on page 115](#).

STO Bypass Prompt When the Safety Controller is in Program Mode

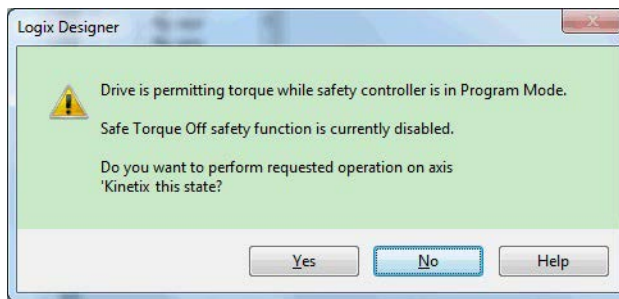

The warning in [STO Bypass Prompt When the Safety Controller is in Program Mode on page 115](#) is displayed the first time a motion direct command is issued.

After you acknowledge the warning message by clicking Yes, torque is permitted by the drive and a warning message is indicated in the software as shown in [Safety State Indications After Controller Transitions to Program Mode \(MDC Executing\) on page 115](#). The controller will report Safety state = Not Running (Torque Permitted), Axis state = Stopped/Running, and Persistent Warning = Safe Torque Off Bypassed.

IMPORTANT Switch the controller to Run mode to exit Motion Direct Command mode and end the bypass of the STO function.

Safety State Indications After Controller Transitions to Program Mode (MDC Executing)

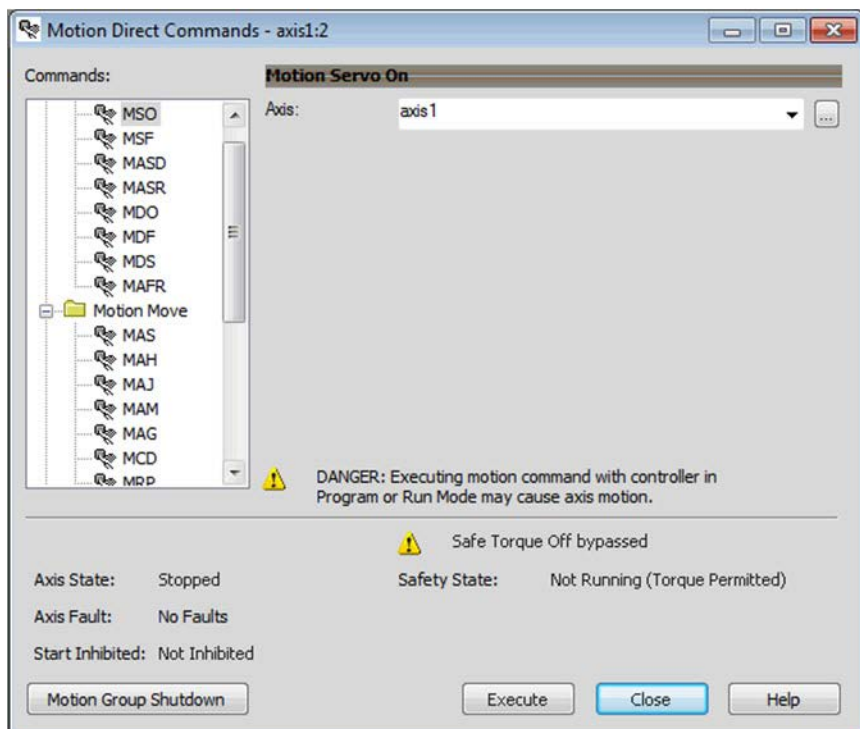

IMPORTANT The persistent warning message text Safe Torque Off bypassed appears when a motion direct command is executed.

The warning message persists - even after the dialog is closed and reopened - as long as the integrated safety drive is in STO Bypass mode.

The persistent warning message is removed only after the integrated safety drive is restored to the Safe state.

Torque Permitted in a Multi-workstation Environment

The warning in [STO Bypass Prompt When MDC is Issued in Multi-workstation Environment on page 116](#) is displayed to notify a second user working in a multi-workstation environment that the first user has placed the integrated safety drive in the STO state and that the current action is about to bypass the STO state and permit torque.

STO Bypass Prompt When MDC is Issued in Multi-workstation Environment

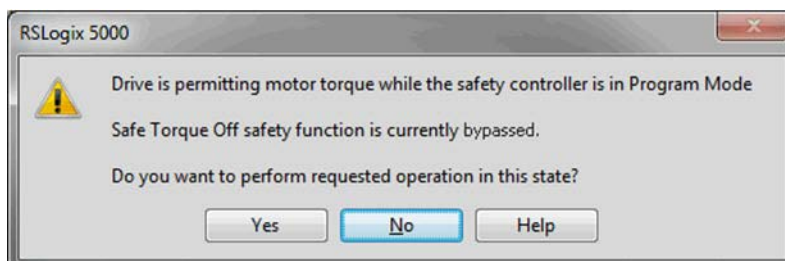

Warning Icon and Text in Axis Properties

In addition to the other warnings that require your acknowledgment, the Logix Designer application also provides warning icons and persistent warning messages in other Axis Properties dialog boxes when the integrated safety drive is in STO Bypass mode.

Axis and Safe State Indications on the Hookup Services Dialog Box

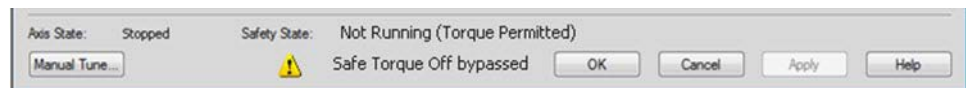

Axis and Safe State Indications on Motion Direct Commands Dialog Box

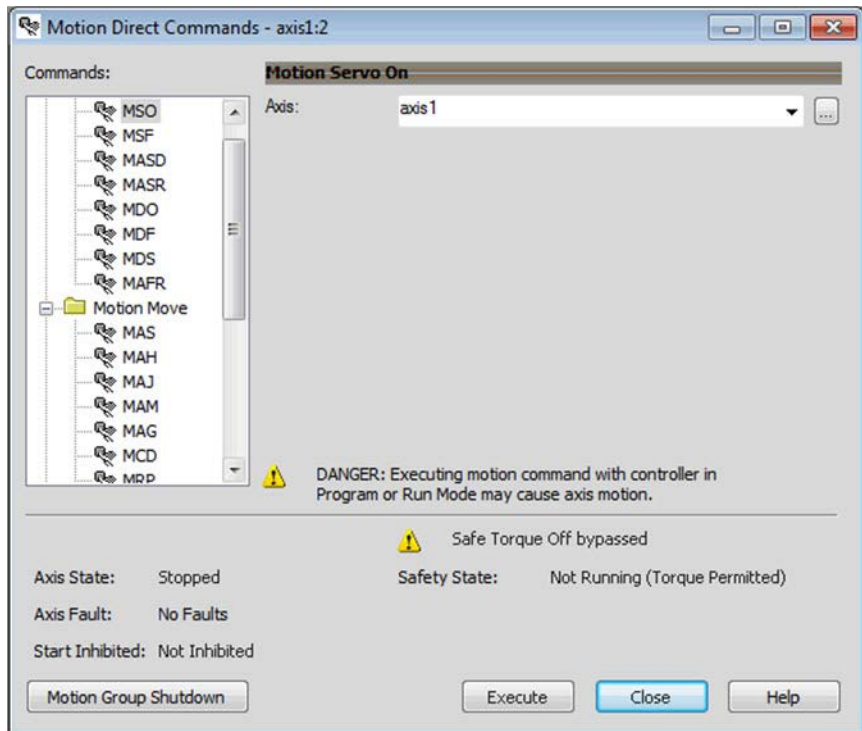

Axis and Safe State Indications on the Motion Console Dialog Box

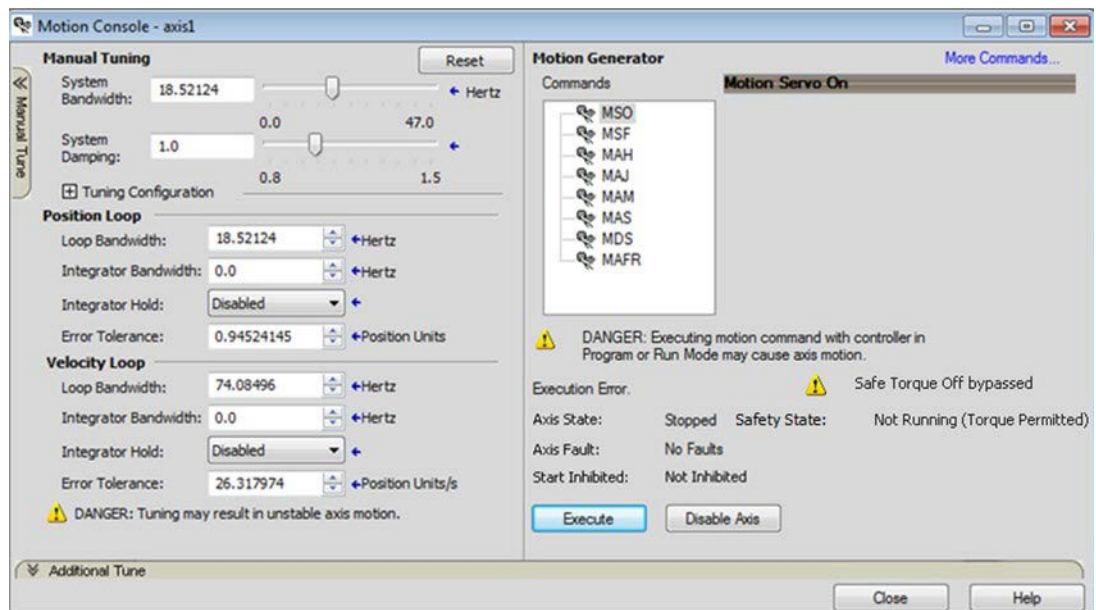

Functional Safety Considerations



ATTENTION: Before maintenance work can be performed in Program mode, the developer of the application must consider the implications of allowing motion through motion direct commands and should consider developing logic for run-time maintenance operations to meet the requirements of machine safety operating procedures.



ATTENTION: Motion is allowed and the STO function is not available when motion direct commands are used in Program mode. Motion direct commands issued when the controller is in Program mode cause the drive to bypass the STO Active condition. It is your responsibility to implement additional preventive measures to maintain safety integrity of the machinery during execution of motion direct commands in Program mode.



ATTENTION: To avoid personal injury and damage to equipment in the event of unauthorized access or unexpected motion during authorized access, return the controller to Run mode and remove the key before leaving the machine unattended.

Troubleshooting

This chapter provides troubleshooting tables and related information for your PowerFlex 527 drive.

For information on...	See page...
Safety Precautions	119
Interpret Status Indicators	119
General Troubleshooting	126
Logix5000 Controller and Drive Behavior	127

Safety Precautions

Observe the following safety precautions when troubleshooting your PowerFlex 527 drive.



ATTENTION: Capacitors on the DC bus can retain hazardous voltages after input power has been removed. Before working on the drive, measure the DC bus voltage to verify it has reached less than 50V DC, or wait three minutes. Failure to observe this precaution could result in severe bodily injury or loss of life.



ATTENTION: Do not attempt to defeat or override the drive fault circuits. You must determine the cause of a fault and correct it before you attempt to operate the system. Failure to correct the fault could result in personal injury and/or damage to equipment as a result of uncontrolled machine operation.



ATTENTION: Provide an earth ground for test equipment (oscilloscope) used in troubleshooting. Failure to ground the test equipment could result in personal injury.

Interpret Status Indicators

Refer to these troubleshooting tables to identify faults, potential causes, and the appropriate actions to resolve the fault. If the fault persists after attempting to troubleshoot the system, please contact your Rockwell Automation sales representative for further assistance.

Display Interface

The LCD display provides fault messages and troubleshooting information by using the soft menu items and navigation buttons. See [Understanding the PowerFlex 527 Display and Indicators on page 42](#) for more information.

When the drive enters a fault or inhibit scenario, the fault information will be shown and scrolled across the LCD display.

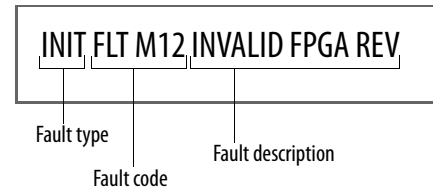

Fault Codes

The fault code tables are designed to help you determine the source of the fault or exception. When a fault condition is detected, the drive performs the appropriate fault action, the fault is displayed, and the fault is added to a persistent fault log (along with diagnostics data). The earlier faults have priority to be displayed.

The drive removes the fault text from the display when a Fault Reset service is sent from the controller and the fault is no longer active. If a fault is still active following a Fault Reset service, the fault is again posted to the display and written to the fault log.

Fault Code Summary

Fault Code Type	Description
FLT Sxx	Standard runtime axis exceptions.
FLT Mxx	
INIT FLT Sxx	Exceptions that prevent normal operation and occur during the initialization process.
INIT FLT Mxx	
INHIBIT Sxx	Exceptions that prevent normal operation and indicate whenever the drive is active.
INHIBIT Mxx	
NODE FLTxx	Exceptions that prevent normal operation of the drive.
NODE ALARM xx	Exceptions that prevent normal operation of the drive, but do not result in any action other than reporting the alarm to the controller.

See [Troubleshoot the Safe Torque-Off Function on page 96](#) for information on troubleshooting SAFE FLT fault codes.

- TIP** Fault codes triggered by conditions that fall outside factory set limits are identified by FL at the end of the display message. For example, FLT S07 – MTR OVERLOAD FL.
- Fault codes triggered by conditions that fall outside user set limits are identified by UL at the end of the display message. For example, FLT S08 – MTR OVERLOAD UL.

FLT Sxx Fault Codes

Exception Code on Display	Exception Text	Problem	Possible Solutions
FLT S03 – MTR OVERSPEED FL	Motor Overspeed Factory Limit Fault	Motor speed has exceeded 590 Hz.	Check control loop tuning.
FLT S04 – MTR OVERSPEED UL	Motor Overspeed User Limit Fault	Motor speed has exceeded the user defined speed limit given by Motor Overspeed User Limit.	Check control loop tuning.
FLT S07 – MTR OVERLOAD FL	Motor Thermal Overload Factory Limit Fault	The motor thermal model has exceeded its factory set thermal capacity limit of 110%.	Modify the command profile to reduce speed or increase time.
FLT S08 – MTR OVERLOAD UL	Motor Thermal Overload User Limit Fault	The motor thermal model has exceeded the thermal capacity limit given by Motor Thermal Overload User Limit.	<ul style="list-style-type: none"> Modify the command profile. Increase the Motor Thermal Overload UL attribute value.

FLT Sxx Fault Codes

Exception Code on Display	Exception Text	Problem	Possible Solutions
FLT S10 – INV OVERCURRENT	Inverter Overcurrent Fault	Inverter current has exceeded the instantaneous current limit (determined by hardware).	<ul style="list-style-type: none"> Check motor power cable for shorts. Verify motor windings are not shorted. Verify motor power wire gauge. Operate within the continuous power rating. Reduce acceleration times.
FLT S11 – INV OVERTEMP FL	Inverter Overtemperature Factory Limit Fault	The measured inverter temperature has exceeded the factory set temperature limit.	<ul style="list-style-type: none"> Modify the command profile to reduce speed or increase time. Reduce drive ambient temperature. Verify airflow through drive is not obstructed.
FLT S13 – INV OVERLOAD FL	Inverter Thermal Overload Factory Limit Fault	The thermal model for the power transistors indicates that the temperature has exceeded the factory set thermal capacity rating of 110%.	Modify the command profile to reduce speed or increase time.
FLT S16 – GROUND CURRENT	Ground Current Factory Limit Fault	The sensing circuitry in the power stage has detected excessive ground current.	<ul style="list-style-type: none"> Check motor power wiring; check power cable for shorts. Replace motor if the fault persists.
FLT S23 – AC PHASE LOSS	AC Single Phase Loss Fault	A single AC input phase was lost while the drive was enabled.	Check AC input voltage on all phases.
FLT S25 – PRECHARGE FAILURE	Pre-charge Failure Fault	The pre-charge circuit monitoring algorithm detected that the DC bus did not reach a factory set voltage level after charging for a period of time.	<ul style="list-style-type: none"> Check AC input voltage on all phases. Check input power wiring. Replace drive if fault persists.
FLT S29 – BUS OVERLOAD FL	Bus Regulator Thermal Overload Factory Limit Fault	The shunt thermal model has exceeded its factory set thermal capacity limit.	<ul style="list-style-type: none"> Modify the duty cycle of the application. Add external shunt for additional capacity. Add capacitor module if needed.
FLT S34 – BUS UNDERVOLT UL	Bus Undervoltage User Limit Fault	DC Bus voltage level is below the user set limit as given by Bus Undervoltage User Limit.	<ul style="list-style-type: none"> Verify voltage level of the incoming AC. Monitor AC power source for glitches or line droop. Install UPS on AC input. Decrease Bus Undervoltage UL attribute value.
FLT S35 – BUS OVERVOLT FL	Bus Overvoltage Factory Limit Fault	DC Bus voltage level is above the factory set limit as determined by the configured input voltage.	<ul style="list-style-type: none"> Change the deceleration or motion profile of all drives connected to the DC bus. Unplug the shunt connector and measure the resistance of the shunt. Replace drive if shunt resistor is open.
FLT S37 – BUS POWER LOSS	Bus Power Loss	DC Bus voltage level is below the Bus Power Loss Threshold for more than the timeout period specified Bus Power Loss Time value.	<ul style="list-style-type: none"> Verify voltage level of the incoming AC. Monitor AC power source for glitches or line droop. Install UPS on AC input.
FLT S41 – FDBK SIGNAL NOISE FL	Feedback Signal Noise Fault	Noise induced A/B channel state changes (illegal states) from a feedback device were detected by the drive. Specifically, the number of these noise events that have occurred on this channel has exceeded the Feedback Noise Factory Limit. The offending feedback channel number is encoded in the associated Fault/Alarm Sub Code.	<ul style="list-style-type: none"> Check motor feedback cable and connector. Cycle power. Check feedback shield connection. Reduce shock and vibration to motor. Replace motor if fault continues.
FLT S45 – FDBK COMM FL	Motor Feedback Data Loss Factory Limit Fault	The number of consecutive missed or corrupted serial data packets from the intelligent feedback device has exceeded a factory set limit.	<ul style="list-style-type: none"> Check motor feedback cable and connector. Check motor power cable and feedback wire shields are secured correctly. Check motor frame is grounded correctly.
FLT S50 – HARDWARE OVERTRAVEL POSITIVE	Hardware Overtravel Positive	Axis moved beyond the physical travel limits in the positive direction and activated the Negative Overtravel limit switch.	<ul style="list-style-type: none"> Check wiring. Verify motion profile. Verify axis configuration in software.
FLT S51 – HARDWARE OVERTRAVEL NEGATIVE	Hardware Overtravel Negative	Axis moved beyond the physical travel limits in the negative direction and activated the Negative Overtravel limit switch.	<ul style="list-style-type: none"> Check wiring. Verify motion profile. Verify axis configuration in software.

FLT Sxx Fault Codes

Exception Code on Display	Exception Text	Problem	Possible Solutions
FLT S54 – POSN ERROR	Excessive Position Error Fault	The position error of the position control loop has exceeded the value given by Position Error Tolerance for a time period given by Position Error Tolerance Time.	<ul style="list-style-type: none"> • Check position loop tuning. • Increase the feedforward gain. • Verify sizing of the drive and motor. • Check motor power wiring. • Increase Position Error Tolerance and/or Position Error Tolerance Time attribute values.
FLT S55 – VEL ERROR	Excessive Velocity Error Fault	The velocity error of the velocity control loop has exceeded the value given by Velocity Error Tolerance for a time period given by Velocity Error Tolerance Time.	<ul style="list-style-type: none"> • Check velocity loop tuning. • Reduce acceleration. • Verify sizing of the drive and motor. • Check motor power wiring. • Increase Velocity Error Tolerance and/or Velocity Error Tolerance Time attribute values.
FLT S56 – OVERTORQUE LIMIT	Overtorque Limit Fault	Motor torque has risen above user defined maximum torque level given by Overtorque Limit for a time period given by Overtorque Limit Time.	<ul style="list-style-type: none"> • Verify Torque Trim value. • Verify motion profile. • Verify sizing of the drive and motor. • Increase Overtorque Limit and/or Overtorque Limit Time attribute values.
FLT S57 – UNDERTORQUE LIMIT	Undertorque Limit Fault	Motor torque has dropped below user defined minimum torque level given by Undertorque Limit for a time period given by Undertorque Limit Time.	<ul style="list-style-type: none"> • Verify motion profile. • Verify sizing of the drive and motor. • Decrease Undertorque Limit and/or Undertorque Limit Time attribute values.
FLT S61 – ENABLE INPUT DEACTIVATED	Enable Input Deactivated	Enable Input has been deactivated while the axis power structure is in Running state, enabled, and supplying current to the DC Bus or motor.	<ul style="list-style-type: none"> • Verify Enable Input level. • Check Enable Input wiring.

FLT Mxx Fault Codes

Exception Code on Display	Exception Text	Problem	Possible Solutions
FLT M10 – CONTROL MODULE OVERTEMPERATURE FL	Control Module Overtemperature Fault	The temperature sensor on the Main Control Board detected excessive heat.	<ul style="list-style-type: none"> • Reduce drive ambient temperature. • Verify airflow through drive is not obstructed. • Check control module internal fan. Replace if error persists.
FLT M19 – DECEL OVERRIDE	Decel Override	The drive is not following a commanded deceleration because it is attempting to limit bus voltage.	<ul style="list-style-type: none"> • Reprogram Bus Regulator Action to eliminate any “Adjustable Freq” selection. • Reprogram Bus Regulator Action to Shunt Regulator and add external shunt. • Correct AC input line instability or add an isolation transformer. • Reset drive.
FLT M21 – MOTOR TEST FAILURE	Motor Test Failure	The Motor Test procedure has failed.	<ul style="list-style-type: none"> • Verify sizing of the drive and motor. • Verify motor data. • Check motor power wiring.
FLT M26 – RUNTIME ERROR	Runtime Error	The drive firmware encountered an unrecoverable runtime error.	<ul style="list-style-type: none"> • Cycle power. • Reset the drive. • Return drive for repair if fault continues.
FLT M28 – SAFETY MODULE COM ERROR	Safety Module Communication Error	Error in communicating to the Safety module.	<ul style="list-style-type: none"> • Cycle power. • Replace module.

INIT FLT Fault Codes

Exception Code on Display	Exception Text	Problem	Possible Solutions
INIT FLT S03 – NVMEM CHKSUM	Nonvolatile memory checksum error	Data in the nonvolatile memory has a checksum error.	<ul style="list-style-type: none"> • Cycle power. • Reset the drive. • Return drive for repair if fault continues.
INIT FLT M14 – INVALID SAFETY FIRMWARE	Invalid Safety Firmware	The safety firmware is not compatible with the drive firmware, or the main safety firmware is missing.	<ul style="list-style-type: none"> • Cycle power. • Upgrade drive firmware. • Return drive for repair if fault continues.
INIT FLT M15 – POWER BOARD	Power Board Checksum Error	The power board has a checksum error.	<ul style="list-style-type: none"> • Cycle power. • Reset the drive. • Return drive for repair if fault continues.

INHIBIT Fault Codes

Exception Code on Display	Exception Text	Problem	Possible Solutions
INHIBIT S01 – AXIS ENABLE INPUT	Axis Enable Input	Axis Enable Input is not active.	<ul style="list-style-type: none"> • Verify Enable Input level. • Check Enable Input wiring.
INHIBIT S02 – MOTOR NOT CONFIGURED	Motor Not Configured	The motor has not been properly configured for use.	Verify motor configuration in the Logix Designer application.
INHIBIT M05 – SAFE TORQUE OFF	Start Inhibit – Safe Torque Off	The safety function has disabled the power structure.	<ul style="list-style-type: none"> • Check safety input wiring. • Check state of safety devices.

NODE FLT Fault Codes

Exception Code on Display	Exception Text	Problem	Possible Solutions
NODE FLT 01 – LATE CTRL UPDATE	Control Connection Update Fault	Several consecutive updates from the controller have been lost.	<ul style="list-style-type: none"> • Remove unnecessary network devices from the motion network. • Change network topology so that fewer devices share common paths. • Use high performance network equipment. • Use shielded cables. • Separate signal wiring from power wiring.
NODE FLT 02 – PROC WATCHDOG nn	Processor Watchdog Fault	The processor on the power board or control board failed to update in a certain amount of time. The nn sub-codes 00...05 are internal and result in the same possible solution.	<ul style="list-style-type: none"> • Cycle power. • Update the drive firmware. • Return drive for repair if fault continues.
NODE FLT 03 – HARDWARE 00	Hardware Fault - PwrIF	Communication with the power board could not be established.	<ul style="list-style-type: none"> • Cycle power. • Update the drive firmware. • Return drive for repair if fault continues.
NODE FLT 03 – HARDWARE 01	Hardware Fault - Piccolo HW	DSP chip on the power board failure.	<ul style="list-style-type: none"> • Cycle power. • Return motor for repair if fault continues.
NODE FLT 03 – HARDWARE 02	Hardware Fault - DSL	Communication with the encoder could not be established.	<ul style="list-style-type: none"> • DSL feedback wiring is incorrect (check against wiring diagram). • DSL feedback wiring is shorted or open. • DSL feedback cable is defective. • Bulletin VPL motor feedback device is defective. • Cycle power. • Return drive for repair if fault continues.
NODE FLT 03 – HARDWARE 03	DSL External Memory Interface Fault	Errors were detected by the DSL external memory interface.	<ul style="list-style-type: none"> • Check DSL feedback device, wiring, and cable. • Cycle power. • Return drive for repair if fault continues.
NODE FLT 05 – CLOCK SKEW FLT	Clock Skew Fault	The controller time and the drive's system time are not the same.	<ul style="list-style-type: none"> • Cycle power. • Check controller and Ethernet switch operation.

NODE FLT Fault Codes

Exception Code on Display	Exception Text	Problem	Possible Solutions
NODE FLT 06 – LOST CTRL CONN	Lost Controller Connection Fault	Communication with the controller has been lost.	<ul style="list-style-type: none"> • Check Ethernet connection. • Check controller and Ethernet switch operation.
NODE FLT 07 – CLOCK SYNC	Clock Sync Fault	Drive's local clock has lost synchronization with controller's clock and was not able to resynchronize within allotted time.	<ul style="list-style-type: none"> • Check Ethernet connection. • Check controller and Ethernet switch operation.
NODE FLT 09 – DUPLICATE IP ADDRESS	Duplicate IP Address Fault	Several consecutive updates from the controller have been lost.	Select an IP address not already in use on the network.

NODE ALARM Fault Codes

Exception Code on Display	Exception Text	Problem	Possible Solutions
NODE ALARM 01 – LATE CTRL UPDATE	Control Connection Update Alarm	Updates from the controller have been late.	<ul style="list-style-type: none"> • Remove unnecessary network devices from the motion network. • Change network topology so that fewer devices share common paths. • Use high performance network equipment. • Use shielded cables. • Separate signal wiring from power wiring.
NODE ALARM 03 – CLOCK JITTER	Clock Jitter Alarm	The sync variance has exceeded the sync threshold while the device is running in sync mode.	<ul style="list-style-type: none"> • Check the Ethernet connection. • Check controller and Ethernet switch operation.
NODE ALARM 04 – CLOCK SKEW ALARM	Clock Skew Alarm	The controller time and the drive's system time are not the same.	<ul style="list-style-type: none"> • Check the Ethernet connection. • Check controller and Ethernet switch operation.
NODE ALARM 05 – CLOCK SYNC ALARM	Clock Sync Alarm	Drive's local clock has lost synchronization with controller's clock for a short time during synchronous operation.	<ul style="list-style-type: none"> • Check the Ethernet connection. • Check controller and Ethernet switch operation.

PowerFlex 527 Drive Status Indicators

The fault status indicator is located between the LCD display and keypad. There are also four status indicators located at the bottom right of the drive and can be seen through the front cover of the control module.

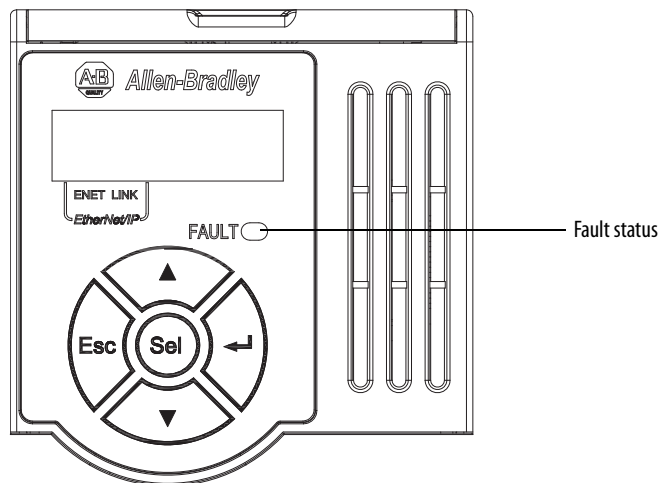

- MOD ○ — Module status
- NET ○ — Network status
- LINK A ○ — Link A status (Ethernet port 1)
- LINK B ○ — Link B status (Ethernet port 2)

Fault Status Indicator

Condition	Safety Supervisor State	CIP Motion Axis State	Governing Object	Identity State
Steady Red	Any State ⁽¹⁾	Aborting	Motion Axis	Major Recoverable or Major Unrecoverable
Steady Red	Any State ⁽¹⁾	Major Faulted	Motion Axis	Major Recoverable or Major Unrecoverable
Steady Red	Abort	Any State ⁽¹⁾	Safety Supervisor	Major Recoverable
Steady Red	Critical Fault	Any State ⁽¹⁾	Safety Supervisor	Major Unrecoverable

(1) "Any State" means any state that has lower precedence.

Module Status Indicator

Condition	Safety Supervisor State	CIP Motion Axis State	Governing Object	Identity State
Flashing Green/Red	Self-Testing	Any State ⁽¹⁾	Safety Supervisor	Device Self-Testing
Flashing Green/Red	Any State ⁽¹⁾	Self-Testing	Motion Axis	Device Self-Testing
Steady Red	Self-Test Exception	Any State ⁽¹⁾	Safety Supervisor	Major Unrecoverable
Flashing Green/Red	Waiting for TUNID ⁽²⁾	Any State ⁽¹⁾	Safety Supervisor	Standby
Flashing Green/Red	Configuring	Any State ⁽¹⁾	Safety Supervisor	Standby
Flashing Green	Idle	Any State ⁽¹⁾	Safety Supervisor	Standby
Flashing Green	<ul style="list-style-type: none"> • Waiting for TUNID with Torque Permitted⁽²⁾⁽³⁾ • Executing • Executing with Torque Permitted⁽⁴⁾ 	<ul style="list-style-type: none"> • Initializing • Pre-Charge • Shutdown • Start Inhibit 	Motion Axis	Standby
Steady Green		<ul style="list-style-type: none"> • Stopped • Stopping • Starting • Running • Testing 	Motion Axis	Operational
Flashing Red or Steady Red	Any State ⁽¹⁾	Aborting	Motion Axis	Major Recoverable or Major Unrecoverable
Flashing Red	Any State ⁽¹⁾	Major Faulted	Motion Axis	Major Recoverable or Major Unrecoverable
Flashing Red	Abort	Any State ⁽¹⁾	Safety Supervisor	Major Recoverable
Steady Red	Critical Fault	Any State ⁽¹⁾	Safety Supervisor	Major Unrecoverable

(1) "Any State" means any state that has lower precedence.

- (2) After Propose_TUNID service request, the Network Status indicator flashes Green/Red (fast flash) until successful Apply_TUNID.
- (3) Unlike many Safety I/O devices, a CIP Motion Safety Drive is free to operate in its "Out of Box" state. This behavior is made explicit by the device specific Safety Supervisor state, Waiting for TUNID with Torque Permitted. In this "Out of Box" state, operation of the CIP Motion Safety Drive is the same as that of a CIP Motion Drive to facilitate commissioning.
- (4) Unlike many Safety I/O devices, a CIP Motion Safety Drive may be operated when the Safety Output assemblies Run/Idle bit is set to Idle. If in the Executing state, the Run/Idle bit is set to Idle, the device is forced to a Safe State. However, if in this condition, the Safety Controller sends a Mode_Change service request with Torque Permitted to the Safety Stop Functions object, drive operation is permitted while the Run/Idle bit remains Idle. See the Safety Stop Function object for details on the Mode_Change service.

Network Status Indicator

Condition	Status
Off	No power applied to the drive or IP address is not configured.
Flashing Green	Drive connection is not established, but has obtained an IP address.
Steady Green	Drive is online and has connections in the established state.
Flashing Red	One or more Exclusive Owner connections has timed out.
Steady Red	Duplicate IP address. IP address specified is already in use.
Flashing Green/Red (slow flash)	The drive performs self-test during powerup.
Flashing Green/Red (fast flash)	Safety Supervisor is waiting for "Apply TUNID" service request.

Link A Status Indicator (Ethernet Port 1)

Condition	Status
Off	Drive is not connected to the network.
Steady Green	Drive is connected to the network but not transmitting data.
Flashing Green	Drive is connected to the network and transmitting data.

Link A Status Indicator (Ethernet Port 2)

Condition	Status
Off	Drive is not connected to the network.
Steady Green	Drive is connected to the network but not transmitting data.
Flashing Green	Drive is connected to the network and transmitting data.

General Troubleshooting

These conditions do not always result in a fault code, but can require troubleshooting to improve performance.

General Troubleshooting

Condition	Potential Cause	Possible Resolution
Axis or system is unstable.	The position feedback device is incorrect or open.	Check wiring.
	Motor tuning limits are set too high.	Run Tune in the Logix Designer application.
	Position loop gain or position controller accel/decel rate is improperly set.	Run Tune in the Logix Designer application.
	Improper grounding or shielding techniques are causing noise to be transmitted into the position feedback or velocity command lines, causing erratic axis movement.	Check wiring and ground.
	Motor Data is incorrectly set (induction motor is not matched to axis module).	<ul style="list-style-type: none"> • Check setups. • Run Motor Test in the Logix Designer application.
	Mechanical resonance.	Notch filter or output filter can be required (refer to Axis Properties dialog box, Output tab in the Logix Designer application).
You cannot obtain the motor acceleration/deceleration that you want.	Torque Limit limits are set too low.	Verify that torque limits are set properly.
	Incorrect motor selected in configuration.	Select the correct motor and run Tune in the Logix Designer application again.
	The system inertia is excessive.	<ul style="list-style-type: none"> • Check motor size versus application need. • Review induction system sizing.
	The system friction torque is excessive.	Check motor size versus application need.
	Available current is insufficient to supply the correct accel/decel rate.	<ul style="list-style-type: none"> • Check motor size versus application need. • Review induction system sizing.
	Acceleration limit is incorrect.	Verify limit settings and correct them, as necessary.
Motor does not respond to a command.	Velocity Limit limits are incorrect.	Verify limit settings and correct them, as necessary.
	The motor wiring is open.	Check the wiring.
	The motor cable shield connection is improper.	<ul style="list-style-type: none"> • Check feedback connections. • Check cable shield connections.
	The motor has malfunctioned.	Repair or replace the motor.
	The coupling between motor and machine has broken (for example, the motor moves, but the load/machine does not).	Check and correct the mechanics.
	Primary operation mode is set incorrectly.	Check and properly set the limit.
	Velocity or torque limits are set incorrectly.	Check and properly set the limits.
Brake connector not wired	Check brake wiring	

General Troubleshooting

Condition	Potential Cause	Possible Resolution
Presence of noise on command or motor feedback signal wires.	Recommended grounding per installation instructions have not been followed.	<ul style="list-style-type: none"> Verify grounding. Route wire away from noise sources. See System Design for the Control of Electrical Noise, publication GMC-RM001.
	Line frequency can be present.	<ul style="list-style-type: none"> Verify grounding. Route wire away from noise sources.
	Variable frequency can be velocity feedback ripple or a disturbance caused by gear teeth or ballscrew, and so forth. The frequency can be a multiple of the motor power transmission components or ballscrew speeds resulting in velocity disturbance.	<ul style="list-style-type: none"> Decouple the motor for verification. Check and improve mechanical performance, for example, the gearbox or ballscrew mechanism.
No rotation	The motor connections are loose or open.	Check motor wiring and connections.
	Foreign matter is lodged in the motor.	Remove foreign matter.
	The motor load is excessive.	Verify the induction system sizing.
	The bearings are worn.	Return the motor for repair.
	The motor brake is engaged (if supplied).	<ul style="list-style-type: none"> Check brake wiring and function. Return the motor for repair.
The motor is not connect to the load.	Check coupling.	
Motor overheating	The duty cycle is excessive.	Change the command profile to reduce accel/decel or increase time.
	The rotor is partially demagnetized causing excessive motor current.	Return the motor for repair.
Abnormal noise	Motor tuning limits are set too high.	Run Tune in the Logix Designer application.
	Loose parts are present in the motor.	<ul style="list-style-type: none"> Remove the loose parts. Return motor for repair. Replace motor.
	Through bolts or coupling is loose.	Tighten bolts.
	The bearings are worn.	Return motor for repair.
	Mechanical resonance.	Notch filter can be required (See Axis Properties dialog box, Output tab in the Logix Designer application).
Erratic operation - Motor locks into position, runs without control or with reduced torque.	Motor power phases U and V, U and W, or V and W reversed.	Check and correct motor power wiring.

Logix5000 Controller and Drive Behavior

By using the Logix Designer application, you can configure how the PowerFlex 527 drives respond when a drive fault/exception occurs.

TIP The INIT FLT xxx faults are always generated after powerup, but before the drive is enabled, so the stopping behavior does not apply.
 NODE ALARM xxx faults do not apply because they do not trigger stopping behavior.

The drive supports fault action for Ignore, Alarm, Minor Fault, and Major Fault as defined in [PowerFlex 527 Drive Exception Action Definitions on page 128](#). See the drive behavior tables beginning on [page 129](#) for information on how the fault and stopping actions apply to each of the exception fault codes.

The drive supports these configurable stopping actions:

- Disable and Coast
- Current Decel and Disable
- Ramped Decel and Disable

PowerFlex 527 Drive Exception Behavior

For PowerFlex 527 drives, you can configure exception behavior in the Logix Designer application from the Axis Properties dialog box, Actions category.

PowerFlex 527 Drive Exception Action Definitions

Exception Action	Definition
Ignore	The controller completely ignores the exception condition. For some exceptions that are fundamental to the operation of the planner, Ignore is not an available option.
Alarm	The controller sets the associated bit in the Motion Alarm Status word, but does not otherwise affect axis behavior. Like Ignore, if the exception is so fundamental to the drive, Alarm is not an available option. When an exception action is set to Alarm, the Alarm goes away by itself when the exceptional condition has cleared.
Fault Status Only – Minor Fault	Like Alarm, Fault Status Only instructs the controller to set the associated bit in the Motion Fault Status word, but does not otherwise affect axis behavior. However, unlike Alarm an explicit Fault Reset is required to clear the fault once the exceptional condition has cleared. Like Ignore and Alarm, if the exception is so fundamental to the drive, Fault Status Only is not an available option.
Stop Planner – Minor Fault	The controller sets the associated bit in the Motion Fault Status word and instructs the Motion Planner to perform a controlled stop of all planned motion at the configured maximum deceleration rate and holds at zero speed. An explicit Fault Reset is required to clear the fault once the exceptional condition has cleared. If the exception is so fundamental to the drive, Stop Planner is not an available option.
Stop Drive – Major Fault	When the exception occurs, the associated bit in the Fault Status word is set and the axis comes to a stop by using the stopping action defined by the drive for the particular exception that occurred. There is no controller based configuration to specify what the stopping action is, the stopping action is device dependent.
Shutdown – Major Fault	When the exception occurs, the drive brings the motor to a stop by using the stopping action defined by the drive (as in Stop Drive) and the power module is disabled. An explicit Shutdown Reset is required to restore the drive to operation.

Only selected drive exceptions are configurable. In the fault behavior tables, the controlling attribute is given for programmable fault actions.

Logix Designer Axis Properties - Actions Category

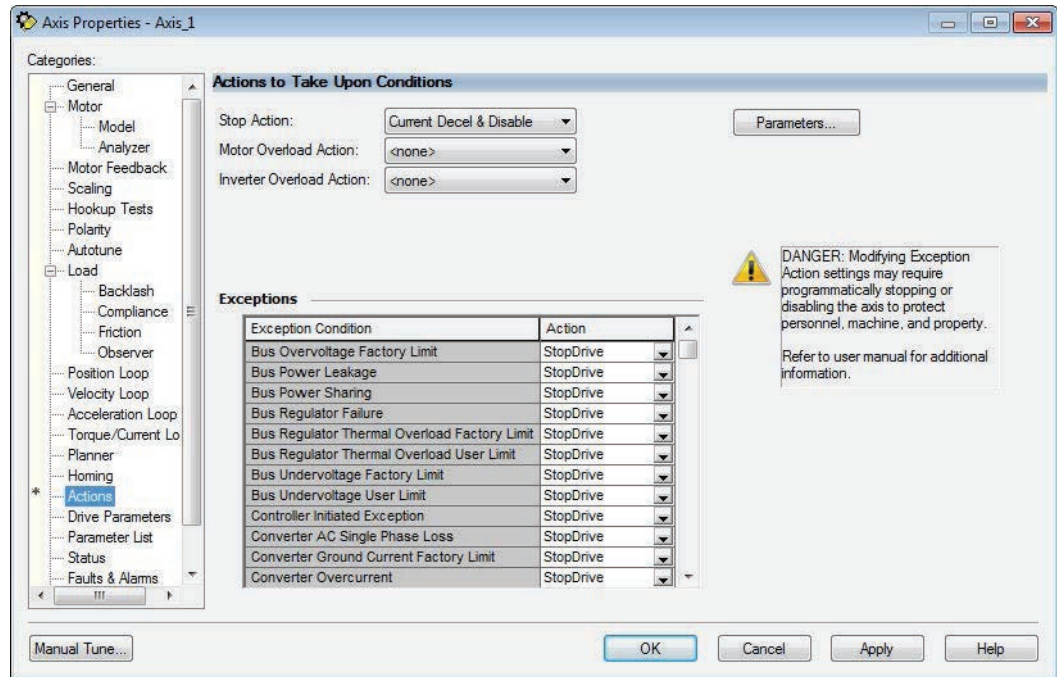

Drive Behavior, FLT Sxx Fault Codes

Exception Fault Code	Exception Text	Induction Motor	Fault Action				Best Available Stopping Action (applies to major faults)
			Ignore	Alarm	Minor Fault	Major Fault	
FLT S03 – MTR OVERSPEED FL	Motor Overspeed Factory Limit Fault	X				X	Disable and Coast
FLT S04 – MTR OVERSPEED UL	Motor Overspeed User Limit Fault	X	X	X	X	X	Disable and Coast
FLT S07 – MTR OVERLOAD FL	Motor Thermal Overload Factory Limit Fault	X				X	Current Decel and Disable
FLT S08 – MTR OVERLOAD UL	Motor Thermal OverLoad User Limit Fault	X	X	X	X	X	Ramped Decel and Disable
FLT S10 – INV OVERCURRENT	Inverter Overcurrent Fault	X				X	Disable and Coast
FLT S11 – INV OVERTEMP FL	Inverter Overtemperature Factory Limit Fault	X				X	Disable and Coast
FLT S13 – INV OVERLOAD FL	Inverter Thermal Overload Factory Limit Fault	X				X	Disable and Coast
FLT S16 – GROUND CURRENT	Ground Current Factory Limit Fault	X				X	Disable and Coast
FLT S23 – AC PHASE LOSS	AC Single Phase Loss Fault	X	X	X	X	X	Disable and Coast
FLT S25 – PRECHARGE FAILURE	Pre-charge Failure Fault	X				X	Disable and Coast
FLT S29 – BUS OVERLOAD FL	Bus Regulator Thermal OverLoad Factory Limit Fault	X				X	Disable and Coast
FLT S34 – BUS UNDERVOLT UL	Bus Undervoltage User Limit Fault	X	X	X	X	X	Disable and Coast
FLT S35 – BUS OVERVOLT FL	Bus Overvoltage Factory Limit Fault	X				X	Disable and Coast
FLT S37 – BUS POWER LOSS	Bus Power Loss	X	X	X	X	X	Disable and Coast
FLT S41 – FDBK SIGNAL NOISE FL	Feedback Signal Noise Fault	X	X	X	X	X	Disable and Coast
FLT S45 – MTR FDBK COMM FL	Motor Feedback Data Loss Factory Limit Fault	X				X	Disable and Coast
FLT S50 – HARDWARE OVERTRAVEL POSITIVE	Hardware Overtravel Positive	X	X	X	X	X	Current Decel and Disable
FLT S51 – HARDWARE OVERTRAVEL NEGATIVE	Hardware Overtravel Negative	X	X	X	X	X	Current Decel and Disable
FLT S54 – POSN ERROR	Excessive Position Error Fault	X	X	X	X	X	Disable and Coast
FLT S55 – VEL ERROR	Excessive Velocity Error Fault	X	X	X	X	X	Disable and Coast
FLT S56 – OVERTORQUE LIMIT	Overtorque Limit Fault	X	X	X	X	X	Disable and Coast
FLT S57 – UNDERTORQUE LIMIT	Undertorque Limit Fault	X	X	X	X	X	Disable and Coast
FLT S61 – ENABLE INPUT DEACTIVATED	Enable Input Deactivated	X	X	X	X	X	Disable and Coast

Drive Behavior, FLT Mxx Fault Codes

Exception Fault Code	Exception Text	Induction Motor	Fault Action				Best Available Stopping Action (applies to major faults)
			Ignore	Alarm	Minor Fault	Major Fault	
FLT M10 – CONTROL MODULE OVERTEMPERATURE FL	Control Module Overtemperature Fault	X				X	Disable and Coast
FLT M19 – DECEL OVERRIDE	Decel Override	X	X	X	X	X	Disable and Coast
FLT M21 – MOTOR TEST FAILURE	Motor Test Failure	X				X	Disable and Coast
FLT M26 – RUNTIME ERROR	Runtime Error	X				X	Disable and Coast
FLT M28 – SAFETY COMM	Safety Module Communication Error	X				X	Disable and Coast







Drive Behavior, NODE FLT xx Fault Codes

Exception Fault Code	Exception Text	Induction Motor	Fault Action				Best Available Stopping Action (applies to major faults)
			Ignore	Alarm	Minor Fault	Major Fault	
NODE FLT 01 – LATE CTRL UPDATE	Control Connection Update Fault	X				X	Current Decel and Disable
NODE FLT 02 – PROC WATCHDOG	Processor Watchdog Fault	X				X	Disable and Coast
NODE FLT 03 – HARDWARE	Hardware Fault	X				X	Disable and Coast
NODE FLT 05 – CLOCK SKEW FLT	Clock Skew Fault	X				X	Disable and Coast
NODE FLT 06 – LOST CTRL CONN	Lost Controller Connection Fault	X				X	Current Decel and Disable
NODE FLT 07 – CLOCK SYNC	Clock Sync Fault	X				X	Disable and Coast
NODE FLT 09 – DUPLICATE IP ADDRESS	Duplicate IP Address Fault	X				X	Disable and Coast

Supplemental Drive Information

For information on...	See page...
Certifications	131
Environmental Specifications	132
Technical Specifications	133
Power Specifications	136

Certifications

Certifications	PowerFlex 527
c-UL-us 	Listed to UL508C and CAN/CSA-C22.2 No. 14-05.
RCM 	Australian Communications and Media Authority In conformity with the following: Radiocommunications Act: 1992 Radiocommunications Standard: 2008 Radiocommunications Labelling Notice: 2008 Standards applied: EN 61800-3:2004+A1:2012
CE 	In conformity with the following European Directives: Low Voltage Directive 2006/95/EC: 61800-5-1 EMC Directive 2004/108/EC: EN 61800-3 Machine Directive 2006/42/EC: EN 60261
TUV 	TÜV Rheinland Standards applied: EN ISO 13849-1:2008+AC:2009 EN 61800-5-2:2007 EN 62061:2005+A1:2013 EN 60204-1:2006+A1:2009 IEC 61508 Part 1-7:2010 Certified to ISO 13849-1 SIL3/PLe with embedded Safe Torque-Off function Certified to ISO 61800-5-2 and EN 62061 SIL3/PLe with Network Torque-Off function Meets Functional Safety (FS) when used with embedded Safe Torque-Off function
KCC	Korean Registration of Broadcasting and Communications Equipment Compliant with the following standards: Article 58-2 of Radio Waves Act, Clause 3
EAC 	Customs Union: Low Voltage TR CU 004/2011 EMC TR CU 020/2011
AC 156	Tested by Trentec to be compliant with AC156 Acceptance Criteria for Seismic Qualification Testing of Nonstructural Components and 2003 International Building Code for worst-case seismic level for USA excluding site class F
EPRI 	Electric Power Research Institute Certified compliant with the following standards: SEMI F47 IEC 61000-4-34

Certifications	PowerFlex 527
ODVA 	ODVA conformance tested to EtherNet/IP specifications
Lloyd's Register	Lloyd's Register Type Approval Certificate 15/80016(E1)
IEEE P1668	Product meets the requirements of IEEE P1668
RoHS	Compliant with the European "Restriction of Hazardous Substances" Directive

The drive is also designed to meet the appropriate portions of the following specifications:

NFPA 70 - US National Electrical Code

NEMA ICS 7.1 - Safety standards for Construction and Guide for Selection, Installation and Operation of Adjustable Speed Drive Systems.

Environmental Specifications

Specifications	PowerFlex 527
Altitude: Without derating: With derating:	See Current Derating Curves on page 13 for derating guidelines. 1000 m (3300 ft) max. Up to 4000 m (13,200 ft) max., with the exception of 600V drives @ 2000 m (6600 ft) max.
Max. Surrounding Air Temperature Without derating: With derating:	See Current Derating Curves on page 13 for derating guidelines. -20...50 °C (-4...122 °F) -20...60 °C (-4...140 °F) or -20...70 °C (-4...158 °F) with optional Control Module Fan kit.
Storage Temperature: Frame A...D: Frame E:	-40...85 °C (-40...185 °F) -40...70 °C (-40...158 °F)

Atmosphere:

IMPORTANT

Drive **must not** be installed in an area where the ambient atmosphere contains volatile or corrosive gas, vapors or dust. If the drive is not going to be installed for a period of time, it must be stored in an area where it will not be exposed to a corrosive atmosphere.

Relative Humidity:	0...95% noncondensing
Shock:	Complies with IEC 60068-2-27
Vibration:	Complies with IEC 60068-2-6:2007

Frame Size	Operating and Nonoperating		Nonoperating (Transportation)	
	Force (Shock/Vibration)	Mounting Type	Force (Shock/Vibration)	Mounting Type
A	15 g / 2 g	DIN rail or screw	30 g / 2.5 g	Screw only
B	15 g / 2 g	DIN rail or screw	30 g / 2.5 g	Screw only
C	15 g / 2 g	DIN rail or screw	30 g / 2.5 g	Screw only
D	15 g / 2 g	Screw only	30 g / 2.5 g	Screw only
E	15 g / 1.5 g	Screw only	30 g / 2.5 g	Screw only

Conformal Coating:	Complies with: IEC 60721-3-3 to level 3C2 (chemical and gases only)
Surrounding Environment Pollution Degree Pollution Degree 1 & 2:	See Pollution Degree Ratings According to EN 61800-5-1 on page 34 for descriptions. All enclosures acceptable.
Sound Pressure Level (A-weighted) Frame A & B: Frame C: Frame D: Frame E:	Measurements are taken 1 m from the drive. Maximum 53 dBA Maximum 57 dBA Maximum 64 dBA Maximum 68 dBA

Technical Specifications

Protection

Specifications	PowerFlex 527
Bus Overvoltage Trip	
100...120V AC Input:	405V DC bus (equivalent to 150V AC incoming line)
200...240V AC Input:	405V DC bus (equivalent to 290V AC incoming line)
380...480V AC Input:	810V DC bus (equivalent to 575V AC incoming line)
525...600V AC Input:	1005V DC bus (equivalent to 711V AC incoming line)
Bus Undervoltage Trip	
100...120V AC Input:	190V DC bus (equivalent to 75V AC incoming line)
200...240V AC Input:	190V DC bus (equivalent to 150V AC incoming line)
380...480V AC Input:	390V DC bus (equivalent to 275V AC incoming line)
525...600V AC Input:	487V DC bus (equivalent to 344V AC incoming line)
Power Ride-Thru:	100 ms
Logic Control Ride-Thru:	0.5 s minimum, 2 s typical
Electronic Motor Overload Protection:	Provides class 10 motor overload protection according to NEC article 430 and motor over-temperature protection according to NEC article 430.126 (A) (2). UL 508C File 29572.
Overcurrent:	200% hardware limit, 300% instantaneous fault
Ground Fault Trip:	Phase-to-ground on drive output
Short Circuit Trip:	Phase-to-phase on drive output

Electrical

Specifications	PowerFlex 527
Voltage Tolerance:	-15% / +10%
Frequency Tolerance:	47...63 Hz
Input Phases:	Three-phase input provides full rating. Single-phase input provides 35% rating on three-phase drives.
Displacement Power Factor:	0.98 across entire speed range
Maximum Short Circuit Rating:	100,000 Amps Symmetrical
Actual Short Circuit Rating:	Determined by AIC Rating of installed fuse/circuit breaker
Transistor Type:	Isolated Gate Bipolar Transistor (IGBT)
Internal DC Bus Choke	Only for Frame E drive ratings
200...240V AC Input:	11 kW (15 HP)
380...480V AC Input:	15...18.5 kW (20...25 HP) – Heavy Duty
525...600V AC Input:	15...18.5 kW (20...25 HP) – Heavy Duty

Control

Specifications	PowerFlex 527
Method	<ul style="list-style-type: none"> • Frequency Control: <ul style="list-style-type: none"> – Volts per Hertz (V/Hz) – Sensorless Vector Control (SVC) – Sensorless Vector Control (SVC) Economizer • Position Loop: <ul style="list-style-type: none"> – Closed Loop Position Vector Control (with optional encoder card) • Velocity Loop: <ul style="list-style-type: none"> – Closed Loop Velocity Vector Control (with optional encoder card)
Carrier Frequency	2...8 kHz, Drive rating based on 4 kHz
Frequency Accuracy	
Digital Input:	Within $\pm 0.05\%$ of set output frequency
Analog Input:	Within 0.5% of maximum output frequency, 10-Bit resolution
Analog Output:	$\pm 2\%$ of full scale, 10-Bit resolution
Performance	
V/Hz (Volts per Hertz):	$\pm 1\%$ of base speed across a 60:1 speed range
SVC (Sensorless Vector):	$\pm 0.5\%$ of base speed across a 100:1 speed range
SVC Economizer:	$\pm 0.5\%$ of base speed across a 100:1 speed range

Specifications	PowerFlex 527
Performance with Encoder Closed Loop Velocity Vector Control:	±0.1% of base speed across a 100:1 speed range
Output Voltage Range:	0V to rated motor voltage
Output Frequency Range:	0...500 Hz (programmable)
Efficiency:	97.5% (typical)
Stop Modes:	Multiple programmable stop modes including – Disable & Coast, Current Decel & Disable, and Ramp Decel & Hold
Accel/Decel:	“REAL” tag programmable with Studio 5000 motion instructions. For more information see the Logix5000 Motion Controllers Instructions Reference Manual, publication MOTION-RM002 .
Intermittent Overload Normal Duty:	110% Overload capability for up to 60 s, 150% for up to 3 s Applies for power rating above 15 kW (20 HP) only. Based on 480V drive rating
Heavy Duty:	150% Overload capability for up to 60 s, 180% for up to 3 s (200% programmable)

Control Inputs

Specifications	PowerFlex 527		
Digital	Bandwidth:	10 Rad/s for open and closed loop	
	Quantity:	(4) Programmable	
	Current:	6 mA	
	Type Source Mode (SRC): Sink Mode (SNK):	18...24V = ON, 0...6V = OFF 0...6V = ON, 18...24V = OFF	
Analog	Quantity:	(2) Isolated, ±10V and 4-20mA	
	Specification Resolution: ±10V DC Analog: 4-20mA Analog: External Pot:	10-bit 100k ohm input impedance 250 ohm input impedance 1...10k ohm, 2 W minimum	
	Safety (per channel)	Input Current:	<10 mA
		Input ON Voltage, max:	18...26.4V DC
Input OFF Voltage, max:		5V DC	
Input ON Current:		10 mA	
Input OFF Current:		500 µA	
Pulse Rejection Width:		700 µs	
External Power Supply:		SELV/PELV	
Input Type:	Optically isolated and reverse voltage protected		

Control Outputs

Specifications		PowerFlex 527
Relay	Quantity:	(2) 1 Programmable Form A and 1 Programmable Form B
	Specification Resistive Rating: Inductive Rating:	3.0 A @ 30V DC, 3.0 A @ 125V, 3.0 A @ 240V AC 0.5 A @ 30V DC, 0.5 A @ 125V, 0.5 A @ 240V AC
Opto	Quantity:	(2) Programmable
	Specification:	30V DC, 50 mA Non-inductive
Analog	Quantity:	(1) Non-Isolated 0-10V or 0-20 mA See Analog Output on page 33 for instructions on setting the jumper. See Setting the ACO/AVO Attribute on page 164 for instructions on setting the attribute.
	Specification Resolution: 0-10V DC Analog: 0-20 mA Analog:	10-bit 1 k ohm minimum 525 ohm maximum

Encoder

Specifications	PowerFlex 527
Type:	Incremental, dual channel
Supply:	5V, 12V, 250 mA
Quadrature:	90°, ±27° @ 25 °C
Duty Cycle:	50%, +10%
Requirements:	Encoders must be line driver type, quadrature (dual channel), 3.5...26V DC output, single-ended or differential and capable of supplying a minimum of 10 mA per channel. Allowable input is DC up to a maximum frequency of 250 kHz. The encoder I/O automatically scales to allow 5V, 12V and 24V DC nominal voltages.

Power Specifications

Watts Loss

PowerFlex 527 Estimated Watts Loss (Rated Load, Speed & PWM)

Voltage	Output Current (A)	Total Watts Loss
100...120V, 50/60 Hz 1-Phase	2.5	27.0
	4.8	53.0
	6.0	67.0
200...240V, 50/60 Hz 1-Phase	2.5	29.0
	4.8	50.0
	8.0	81.0
	11.0	111.0
200...240V, 50/60 Hz 1-Phase w/ EMC Filter	2.5	29.0
	4.8	53.0
	8.0	84.0
	11.0	116.0
200...240V, 50/60 Hz 3-Phase	2.5	29.0
	5.0	50.0
	8.0	79.0
	11.0	107.0
	17.5	148.0
	24.0	259.0
	32.2	323.0
	48.3	584.0
380...480V, 50/60 Hz 3-Phase	1.4	27.0
	2.3	37.0
	4.0	62.0
	6.0	86.0
	10.5	129.0
	13.0	170.0
	17.0	221.0
	24.0	303.0
380...480V, 50/60 Hz 3-Phase w/ EMC Filter	1.4	27.0
	2.3	37.0
	4.0	63.0
	6.0	88.0
	10.5	133.0
	13.0	175.0
	17.0	230.0
	24.0	313.0
	30.0	402.0
	37.0	602.0
43.0	697.0	

PowerFlex 527 Estimated Watts Loss (Rated Load, Speed & PWM)

Voltage	Output Current (A)	Total Watts Loss
525...600V, 50/60 Hz 3-Phase	0.9	22.0
	1.7	32.0
	3.0	50.0
	4.2	65.0
	6.6	95.0
	9.9	138.0
	12.0	164.0
	19.0	290.0
	22.0	336.0
	27.0	466.0
32.0	562.0	

*Input Current Scaling***PowerFlex 527 Input Current Scaled By Motor Current**

Catalog Number	Output				Input			
	1	2	3	4	5	6	7	8
100...120V AC (-15%, +10%) – 1-Phase Input, 0...230V 3-Phase Output								
25C-V2P5N104	2.5	2.0	1.6	1.3	9.6	7.7	6.2	4.8
25C-V4P8N104	4.8	3.8	3.1	2.4	19.2	15.4	12.5	9.6
25C-V6PON104	6.0	4.8	3.9	3.0	24.0	19.2	15.6	12.0
200...240V AC (-15%, +10%) – 1-Phase Input, 0...230V 3-Phase Output								
25C-A2P5N104	2.5	2.0	1.6	1.3	6.5	5.2	4.2	3.3
25C-A4P8N104	4.8	3.8	3.1	2.4	10.7	8.6	7.0	5.4
25C-A8PON104	8.0	6.4	5.2	4.0	18.0	14.4	11.7	9.0
25C-A011N104	11.0	8.8	7.2	5.5	22.9	18.3	14.9	11.5
200...240V AC (-15%, +10%) – 1-Phase Input with EMC Filter, 0...230V 3-Phase Output								
25C-A2P5N114	2.5	2.0	1.6	1.3	6.5	5.2	4.2	3.3
25C-A4P8N114	4.8	3.8	3.1	2.4	10.7	8.6	7.0	5.4
25C-A8PON114	8.0	6.4	5.2	4.0	18.0	14.4	11.7	9.0
25C-A011N114	11.0	8.8	7.2	5.5	22.9	18.3	14.9	11.5
200...240V AC (-15%, +10%) – 3-Phase Input, 0...230V 3-Phase Output								
25C-B2P5N104	2.5	2.0	1.6	1.3	2.7	2.2	1.8	1.4
25C-B5PON104	5.0	4.0	3.2	2.5	5.8	4.6	3.8	2.9
25C-B8PON104	8.0	6.4	5.2	4.0	9.5	7.6	6.2	4.8
25C-B011N104	11.0	8.8	7.2	5.5	13.8	11.0	9.0	6.9
25C-B017N104	17.5	14.0	11.4	8.8	21.1	16.9	13.7	10.6
25C-B024N104	24.0	19.2	15.6	12.0	26.6	21.3	17.3	13.3
25C-B032N104	32.2	25.8	20.9	16.1	34.8	27.8	22.6	17.4
25C-B048N104	48.3	38.6	31.4	24.2	44.0	35.2	28.6	22.0
25C-B062N104	62.1	49.7	40.4	31.1	56.0	44.8	36.4	28.0
380...480V AC (-15%, +10%) – 3-Phase Input, 0...460V 3-Phase Output								
25C-D1P4N104	1.4	1.1	0.9	0.7	1.9	1.5	1.2	1.0
25C-D2P3N104	2.3	1.8	1.5	1.2	3.2	2.6	2.1	1.6
25C-D4PON104	4.0	3.2	2.6	2.0	5.7	4.6	3.7	2.9
25C-D6PON104	6.0	4.8	3.9	3.0	7.5	6.0	4.9	3.8
25C-D010N104	10.5	8.4	6.8	5.3	13.8	11.0	9.0	6.9
25C-D013N104	13.0	10.4	8.5	6.5	15.4	12.3	10.0	7.7
25C-D017N104	17.0	13.6	11.1	8.5	18.4	14.7	12.0	9.2

PowerFlex 527 Input Current Scaled By Motor Current

Catalog Number	Output				Input			
	1	2	3	4	5	6	7	8
25C-D024N104	24.0	19.2	15.6	12.0	26.4	21.1	17.2	13.2
25C-D030N104	30.0	24.0	19.5	15.0	33.0	26.4	21.5	16.5
380...480V AC (-15%, +10%) – 3-Phase Input with EMC Filter, 0...460V 3-Phase Output								
25C-D1P4N114	1.4	1.1	0.9	0.7	1.9	1.5	1.2	1.0
25C-D2P3N114	2.3	1.8	1.5	1.2	3.2	2.6	2.1	1.6
25C-D4P0N114	4.0	3.2	2.6	2.0	5.7	4.6	3.7	2.9
25C-D6P0N114	6.0	4.8	3.9	3.0	7.5	6.0	4.9	3.8
25C-D010N114	10.5	8.4	6.8	5.3	13.8	11.0	9.0	6.9
25C-D013N114	13.0	10.4	8.5	6.5	15.4	12.3	10.0	7.7
25C-D017N114	17.0	13.6	11.1	8.5	18.4	14.7	12.0	9.2
25C-D024N114	24.0	19.2	15.6	12.0	26.4	21.1	17.2	13.2
25C-D030N114	30.0	24.0	19.5	15.0	33.0	26.4	21.5	16.5
25C-D037N114	37.0	29.6	24.1	18.5	33.7	27.0	21.9	16.9
25C-D043N114	43.0	34.4	28.0	21.5	38.9	31.1	25.3	19.5
525...600V AC (-15%, +10%) – 3-Phase Input, 0...575V 3-Phase Output								
25C-E0P9N104	0.9	0.7	0.6	0.5	1.2	1.0	0.8	0.6
25C-E1P7N104	1.7	1.4	1.1	0.9	2.3	1.8	1.5	1.2
25C-E3P0N104	3.0	2.4	2.0	1.5	3.8	3.0	2.5	1.9
25C-E4P2N104	4.2	3.4	2.7	2.1	5.3	4.2	3.4	2.7
25C-E6P6N104	6.6	5.3	4.3	3.3	8.0	6.4	5.2	4.0
25C-E9P9N104	9.9	7.9	6.4	5.0	11.2	9.0	7.3	5.6
25C-E012N104	12.0	9.6	7.8	6.0	13.5	10.8	8.8	6.8
25C-E019N104	19.0	15.2	12.4	9.5	24.0	19.2	15.6	12.0
25C-E022N104	22.0	17.6	14.3	11.0	27.3	21.8	17.7	13.7
25C-E027N104	27.0	21.6	17.6	13.5	24.7	19.8	16.1	12.4
25C-E032N104	32.0	25.6	20.8	16.0	29.2	23.4	19.0	14.6

Accessories and Dimensions

Product Selection

Catalog Number Description

25C	-	V	2P5	N	1	0	4
Drive		Voltage Rating	Rating	Enclosure	HIM	Emission Class	Version

PowerFlex 527 Drive Ratings

Output Ratings							
Normal Duty		Heavy Duty		Output Current (A)	Input Voltage Range	Frame Size	Catalog No.
HP	kW	HP	kW				
100...120V AC (-15%, +10%) – 1-Phase Input, 0...230V 3-Phase Output							
0.5	0.4	0.5	0.4	2.5	85...132	A	25C-V2P5N104
1.0	0.75	1.0	0.75	4.8	85...132	B	25C-V4P8N104
1.5	1.1	1.5	1.1	6.0	85...132	B	25C-V6P0N104
200...240V AC (-15%, +10%) – 1-Phase Input, 0...230V 3-Phase Output							
0.5	0.4	0.5	0.4	2.5	170...264	A	25C-A2P5N104
1.0	0.75	1.0	0.75	4.8	170...264	A	25C-A4P8N104
2.0	1.5	2.0	1.5	8.0	170...264	B	25C-A8P0N104
3.0	2.2	3.0	2.2	11.0	170...264	B	25C-A011N104
200...240V AC (-15%, +10%) – 1-Phase Input with EMC Filter, 0...230V 3-Phase Output							
0.5	0.4	0.5	0.4	2.5	170...264	A	25C-A2P5N114
1.0	0.75	1.0	0.75	4.8	170...264	A	25C-A4P8N114
2.0	1.5	2.0	1.5	8.0	170...264	B	25C-A8P0N114
3.0	2.2	3.0	2.2	11.0	170...264	B	25C-A011N114
200...240V AC (-15%, +10%) – 3-Phase Input, 0...230V 3-Phase Output							
0.5	0.4	0.5	0.4	2.5	170...264	A	25C-B2P5N104
1.0	0.75	1.0	0.75	5.0	170...264	A	25C-B5P0N104
2.0	1.5	2.0	1.5	8.0	170...264	A	25C-B8P0N104
3.0	2.2	3.0	2.2	11.0	170...264	A	25C-B011N104
5.0	4.0	5.0	4.0	17.5	170...264	B	25C-B017N104
7.5	5.5	7.5	5.5	24.0	170...264	C	25C-B024N104
10.0	7.5	10.0	7.5	32.2	170...264	D	25C-B032N104
15.0	11.0	10.0	7.5	48.3	170...264	E	25C-B048N104
20.0	15.0	15.0	11.0	62.1	170...264	E	25C-B062N104
380...480V AC (-15%, +10%) – 3-Phase Input, 0...460V 3-Phase Output⁽¹⁾							
0.5	0.4	0.5	0.4	1.4	323...528	A	25C-D1P4N104
1.0	0.75	1.0	0.75	2.3	323...528	A	25C-D2P3N104
2.0	1.5	2.0	1.5	4.0	323...528	A	25C-D4P0N104
3.0	2.2	3.0	2.2	6.0	323...528	A	25C-D6P0N104
5.0	4.0	5.0	4.0	10.5	323...528	B	25C-D010N104
7.5	5.5	7.5	5.5	13.0	323...528	C	25C-D013N104
10.0	7.5	10.0	7.5	17.0	323...528	C	25C-D017N104
15.0	11.0	15.0	11.0	24.0	323...528	D	25C-D024N104
20.0	15.0	15.0	11.0	30.0	323...528	D	25C-D030N104

PowerFlex 527 Drive Ratings

Output Ratings					Input Voltage Range	Frame Size	Catalog No.
Normal Duty		Heavy Duty		Output Current (A)			
HP	kW	HP	kW				
380...480V AC (-15%, +10%) – 3-Phase Input with EMC Filter, 0...460V 3-Phase Output							
0.5	0.4	0.5	0.4	1.4	323...528	A	25C-D1P4N114
1.0	0.75	1.0	0.75	2.3	323...528	A	25C-D2P3N114
2.0	1.5	2.0	1.5	4.0	323...528	A	25C-D4P0N114
3.0	2.2	3.0	2.2	6.0	323...528	A	25C-D6P0N114
5.0	4.0	5.0	4.0	10.5	323...528	B	25C-D010N114
7.5	5.5	7.5	5.5	13.0	323...528	C	25C-D013N114
10.0	7.5	10.0	7.5	17.0	323...528	C	25C-D017N114
15.0	11.0	15.0	11.0	24.0	323...528	D	25C-D024N114
20.0	15.0	15.0	11.0	30.0	323...528	D	25C-D030N114
25.0	18.5	20.0	15.0	37.0	323...528	E	25C-D037N114
30.0	22.0	25.0	18.5	43.0	323...528	E	25C-D043N114
525...600V AC (-15%, +10%) – 3-Phase Input, 0...575V 3-Phase Output							
0.5	0.4	0.5	0.4	0.9	446...660	A	25C-E0P9N104
1.0	0.75	1.0	0.75	1.7	446...660	A	25C-E1P7N104
2.0	1.5	2.0	1.5	3.0	446...660	A	25C-E3P0N104
3.0	2.2	3.0	2.2	4.2	446...660	A	25C-E4P2N104
5.0	4.0	5.0	4.0	6.6	446...660	B	25C-E6P6N104
7.5	5.5	7.5	5.5	9.9	446...660	C	25C-E9P9N104
10.0	7.5	10.0	7.5	12.0	446...660	C	25C-E012N104
15.0	11.0	15.0	11.0	19.0	446...660	D	25C-E019N104
20.0	15.0	15.0	11.0	22.0	446...660	D	25C-E022N104
25.0	18.5	20.0	15.0	27.0	446...660	E	25C-E027N104
30.0	22.0	25.0	18.5	32.0	446...660	E	25C-E032N104

(1) A non-filtered drive is not available for 380...480V AC 25 HP (18.5 kW) and 30 HP (22.0 kW) ratings. Filtered drives are available, however you must verify that the application will support a filtered drive.

Dynamic Brake Resistors

Drive Ratings	Input Voltage		Minimum Resistance $\Omega \pm 10\%$	Resistance $\Omega \pm 5\%$	Catalog No. ⁽¹⁾⁽²⁾
	HP	kW			
100...120V 50/60 Hz 1-Phase	0.25	0.2	56	91	AK-R2-091P500
	0.5	0.4	56	91	AK-R2-091P500
	1.0	0.75	56	91	AK-R2-091P500
	1.5	1.1	41	91	AK-R2-091P500
200...240V 50/60 Hz 1-Phase	0.25	0.2	56	91	AK-R2-091P500
	0.5	0.4	56	91	AK-R2-091P500
	1.0	0.75	56	91	AK-R2-091P500
	2.0	1.5	41	91	AK-R2-091P500
	3.0	2.2	32	47	AK-R2-047P500

Dynamic Brake Resistors

Drive Ratings			Minimum Resistance $\Omega \pm 10\%$	Resistance $\Omega \pm 5\%$	Catalog No. ⁽¹⁾⁽²⁾
Input Voltage	HP	kW			
200...240V 50/60 Hz 3-Phase	0.25	0.2	56	91	AK-R2-091P500
	0.5	0.4	56	91	AK-R2-091P500
	1.0	0.75	56	91	AK-R2-091P500
	2.0	1.5	41	91	AK-R2-091P500
	3.0	2.2	32	47	AK-R2-047P500
	5.0	4.0	18	47	AK-R2-047P500
	7.5	5.5	16	30	AK-R2-030P1K2
	10.0	7.5	14	30	AK-R2-030P1K2
	15.0	11.0	14	15	AK-R2-030P1K2 ⁽³⁾
	20.0	15.0	10	15	AK-R2-030P1K2 ⁽³⁾
380...480V 50/60 Hz 3-Phase	0.5	0.4	89	360	AK-R2-360P500
	1.0	0.75	89	360	AK-R2-360P500
	2.0	1.5	89	360	AK-R2-360P500
	3.0	2.2	89	120	AK-R2-120P1K2
	5.0	4.0	47	120	AK-R2-120P1K2
	7.5	5.5	47	120	AK-R2-120P1K2
	10.0	7.5	47	120	AK-R2-120P1K2
	15.0	11.0	43	60	AK-R2-120P1K2 ⁽³⁾
	20.0	15.0	43	60	AK-R2-120P1K2 ⁽³⁾
	25.0	18.5	27	40	AK-R2-120P1K2 ⁽⁴⁾
525...600V 50/60 Hz 3-Phase	0.5	0.4	112	360	AK-R2-360P500
	1.0	0.75	112	360	AK-R2-360P500
	2.0	1.5	112	360	AK-R2-360P500
	3.0	2.2	112	120	AK-R2-120P1K2
	5.0	4.0	86	120	AK-R2-120P1K2
	7.5	5.5	59	120	AK-R2-120P1K2
	10.0	7.5	59	120	AK-R2-120P1K2
	15.0	11.0	59	60	AK-R2-120P1K2 ⁽³⁾
	20.0	15.0	59	60	AK-R2-120P1K2 ⁽³⁾
	25.0	18.5	53	60	AK-R2-120P1K2 ⁽³⁾
30.0	22.0	34	40	AK-R2-120P1K2 ⁽⁴⁾	

(1) The resistors listed in this tables are rated for 5% duty cycle.

(2) Use of Rockwell Automation resistors is always recommended. The resistors listed have been carefully selected for optimizing performance in a variety of applications. Alternative resistors may be used, however, care must be taken when making a selection. See the PowerFlex Dynamic Braking Resistor Calculator, publication [PELEX-AT001](#).

(3) Requires two resistors wired in parallel.

(4) Requires three resistors wired in parallel.

EMC Line Filters

Drive Ratings				Frame Size	Catalog No.
Input Voltage	HP	kW	Current (A)		
100...120V 50/60 Hz 1-Phase	0.25	0.2	1.6	A	25-RF011-AL
	0.5	0.4	2.5	A	25-RF011-AL
	1.0	0.75	4.8	B	25-RF023-BL
	1.5	1.1	6.0	B	25-RF023-BL

EMC Line Filters

Drive Ratings				Frame Size	Catalog No.
Input Voltage	HP	kW	Current (A)		
200...240V 50/60 Hz 1-Phase	0.25	0.2	1.6	A	25-RF011-AL
	0.5	0.4	2.5	A	25-RF011-AL
	1.0	0.75	4.8	A	25-RF011-AL
	2.0	1.5	8.0	B	25-RF023-BL
	3.0	2.2	11.0	B	25-RF023-BL
200...240V 50/60 Hz 3-Phase	0.25	0.2	1.6	A	25-RF014-AL
	0.5	0.4	2.5	A	25-RF014-AL
	1.0	0.75	5.0	A	25-RF014-AL
	2.0	1.5	8.0	A	25-RF014-AL
	3.0	2.2	11.0	A	25-RF014-AL
	5.0	4.0	17.5	B	25-RF021-BL
	7.5	5.5	24.0	C	25-RF027-CL
	10.0	7.5	32.2	D	25-RF035-DL
	15.0	11.0	48.3	E	25-RF056-EL
380...480V 50/60 Hz 3-Phase	0.5	0.4	1.4	A	25-RF7P5-AL
	1.0	0.75	2.3	A	25-RF7P5-AL
	2.0	1.5	4.0	A	25-RF7P5-AL
	3.0	2.2	6.0	A	25-RF7P5-AL
	5.0	4.0	10.5	B	25-RF014-BL
	7.5	5.5	13.0	C	25-RF018-CL
	10.0	7.5	17.0	C	25-RF018-CL
	15.0	11.0	24.0	D	25-RF033-DL
	20.0	15.0	30.0	D	25-RF033-DL
	25.0	18.5	37.0	E	25-RF039-EL
	30.0	22.0	43.0	E	25-RF039-EL ⁽¹⁾
	525...600V 50/60 Hz 3-Phase	0.5	0.4	0.9	A
1.0		0.75	1.7	A	25-RF8P0-BL ⁽²⁾
2.0		1.5	3.0	A	25-RF8P0-BL ⁽²⁾
3.0		2.2	4.2	A	25-RF8P0-BL ⁽²⁾
5.0		4.0	6.6	B	25-RF8P0-BL
7.5		5.5	9.9	C	25-RF014-CL
10.0		7.5	12.0	C	25-RF014-CL
15.0		11.0	19.0	D	25-RF027-DL
20.0		15.0	22.0	D	25-RF027-DL
25.0		18.5	27.0	E	25-RF029-EL
30.0		22.0	32.0	E	25-RF029-EL ⁽¹⁾

(1) EMC Line Filter size is based on the input current of the drive. See the tables on [page 21](#) and [page 22](#) for more information.

(2) This 600V drive rating needs to be matched with a frame B EMC Line Filter.

EMC Plates

Item	Description	Frame Size	Catalog No.
EMC Plate	Optional grounding plate for shielded cables.	A	25-EMC1-FA
		B	25-EMC1-FB
		C	25-EMC1-FC
		D	25-EMC1-FD
		E	25-EMC1-FE

IP 30/NEMA 1/UL Type 1 Kit

Item	Description	Frame Size	Catalog No.
IP 30/NEMA 1/UL Type 1 Kit	Field installed kit. Converts drive to IP 30/NEMA 1/UL Type 1 enclosure. Includes conduit box with mounting screws and plastic top panel.	A	25-JBAA
		B	25-JBAB
		C	25-JBAC
		D	25-JBAD
		E	25-JBAE

Control Module Fan Kit

Item	Description	Frame Size	Catalog No.
Control Module Fan Kit	For use with drive in environments with ambient temperatures up to 70 °C or horizontal mounting.	A...D	25-FAN1-70C
		E	25-FAN2-70C

Incremental Encoder Input Option

Item	Description	Catalog No.
Incremental Encoder Board	Interface to an external incremental encoder.	25-ENC-2

Bulletin 160 to PowerFlex 527 Mounting Adapter Plate

Item	Description	B160 Frame Size	Catalog No.
Mounting Adapter Plate	For use with drive when replacing Bulletin 160 drives in existing installations to a PowerFlex 520-Series drive. Select the catalog number based on the frame size of your Bulletin 160 drive.	A	25-MAP-FA
		B	25-MAP-FB

*Replacement Parts***PowerFlex 527 Power Module**

Item	Description
PowerFlex 527 Power Module	Replacement power module for use with PowerFlex 527 drive. Includes: <ul style="list-style-type: none"> • Power Module • Power Module Front Cover • Power Terminal Guard • Heatsink Fan

Output Ratings						Input Voltage Range	Frame Size	Catalog No.
Normal Duty		Heavy Duty		Output Current (A)				
HP	kW	HP	kW					
100...120V AC (-15%, +10%) – 1-Phase Input, 0...230V 3-Phase Output								
0.5	0.4	0.5	0.4	2.5	85...132	A	25-PM1-V2P5	
1.0	0.75	1.0	0.75	4.8	85...132	B	25-PM1-V4P8	
1.5	1.1	1.5	1.1	6.0	85...132	B	25-PM1-V6P0	
200...240V AC (-15%, +10%) – 1-Phase Input, 0...230V 3-Phase Output								
0.5	0.4	0.5	0.4	2.5	170...264	A	25-PM1-A2P5	
1.0	0.75	1.0	0.75	4.8	170...264	A	25-PM1-A4P8	
2.0	1.5	2.0	1.5	8.0	170...264	B	25-PM1-A8P0	
3.0	2.2	3.0	2.2	11.0	170...264	B	25-PM1-A011	

Output Ratings					Input Voltage Range	Frame Size	Catalog No.
Normal Duty		Heavy Duty		Output Current (A)			
HP	kW	HP	kW				
200...240V AC (-15%, +10%) – 1-Phase Input with EMC Filter, 0...230V 3-Phase Output							
0.5	0.4	0.5	0.4	2.5	170...264	A	25-PM2-A2P5
1.0	0.75	1.0	0.75	4.8	170...264	A	25-PM2-A4P8
2.0	1.5	2.0	1.5	8.0	170...264	B	25-PM2-A8P0
3.0	2.2	3.0	2.2	11.0	170...264	B	25-PM2-A011
200...240V AC (-15%, +10%) – 3-Phase Input, 0...230V 3-Phase Output							
0.5	0.4	0.5	0.4	2.5	170...264	A	25-PM1-B2P5
1.0	0.75	1.0	0.75	5.0	170...264	A	25-PM1-B5P0
2.0	1.5	2.0	1.5	8.0	170...264	A	25-PM1-B8P0
3.0	2.2	3.0	2.2	11.0	170...264	A	25-PM1-B011
5.0	4.0	5.0	4.0	17.5	170...264	B	25-PM1-B017
7.5	5.5	7.5	5.5	24.0	170...264	C	25-PM1-B024
10.0	7.5	10.0	7.5	32.2	170...264	D	25-PM1-B032
15.0	11.0	10.0	7.5	48.3	170...264	E	25-PM1-B048
20.0	15.0	15.0	11.0	62.1	170...264	E	25-PM1-B062
380...480V AC (-15%, +10%) – 3-Phase Input, 0...460V 3-Phase Output							
0.5	0.4	0.5	0.4	1.4	323...528	A	25-PM1-D1P4
1.0	0.75	1.0	0.75	2.3	323...528	A	25-PM1-D2P3
2.0	1.5	2.0	1.5	4.0	323...528	A	25-PM1-D4P0
3.0	2.2	3.0	2.2	6.0	323...528	A	25-PM1-D6P0
5.0	4.0	5.0	4.0	10.5	323...528	B	25-PM1-D010
7.5	5.5	7.5	5.5	13.0	323...528	C	25-PM1-D013
10.0	7.5	10.0	7.5	17.0	323...528	C	25-PM1-D017
15.0	11.0	15.0	11.0	24.0	323...528	D	25-PM1-D024
20.0	15.0	15.0	11.0	30.0	323...528	D	25-PM1-D030
380...480V AC (-15%, +10%) – 3-Phase Input with EMC Filter, 0...460V 3-Phase Output							
0.5	0.4	0.5	0.4	1.4	323...528	A	25-PM2-D1P4
1.0	0.75	1.0	0.75	2.3	323...528	A	25-PM2-D2P3
2.0	1.5	2.0	1.5	4.0	323...528	A	25-PM2-D4P0
3.0	2.2	3.0	2.2	6.0	323...528	A	25-PM2-D6P0
5.0	4.0	5.0	4.0	10.5	323...528	B	25-PM2-D010
7.5	5.5	7.5	5.5	13.0	323...528	C	25-PM2-D013
10.0	7.5	10.0	7.5	17.0	323...528	C	25-PM2-D017
15.0	11.0	15.0	11.0	24.0	323...528	D	25-PM2-D024
20.0	15.0	15.0	11.0	30.0	323...528	D	25-PM2-D030
25.0	18.5	20.0	15.0	37.0	323...528	E	25-PM2-D037
30.0	22.0	25.0	18.5	43.0	323...528	E	25-PM2-D043
525...600V AC (-15%, +10%) – 3-Phase Input, 0...575V 3-Phase Output							
0.5	0.4	0.5	0.4	0.9	446...660	A	25-PM1-E0P9
1.0	0.75	1.0	0.75	1.7	446...660	A	25-PM1-E1P7
2.0	1.5	2.0	1.5	3.0	446...660	A	25-PM1-E3P0
3.0	2.2	3.0	2.2	4.2	446...660	A	25-PM1-E4P2
5.0	4.0	5.0	4.0	6.6	446...660	B	25-PM1-E6P6
7.5	5.5	7.5	5.5	9.9	446...660	C	25-PM1-E9P9
10.0	7.5	10.0	7.5	12.0	446...660	C	25-PM1-E012
15.0	11.0	15.0	11.0	19.0	446...660	D	25-PM1-E019

Output Ratings					Input Voltage Range	Frame Size	Catalog No.
Normal Duty		Heavy Duty		Output Current (A)			
HP	kW	HP	kW				
20.0	15.0	15.0	11.0	22.0	446...660	D	25-PM1-E022
25.0	18.5	20.0	15.0	27.0	446...660	E	25-PM1-E027
30.0	22.0	25.0	18.5	32.0	446...660	E	25-PM1-E032

PowerFlex 527 Control Module

Item	Description	Frame Size	Catalog No.
PowerFlex 527 Control Module	Replacement control module for use with PowerFlex 527 drives. Includes: <ul style="list-style-type: none"> Control Module Control Module Front Cover 	A...E	25C-CTM1

Other Parts

Item	Description	Frame Size	Catalog No.
PowerFlex 527 Control Module Front Cover	Replacement cover for the control module I/O terminals and EtherNet/IP ports.	A...E	25C-CTMFC1
PowerFlex 520-Series Power Module Front Cover	Replacement cover for the PowerFlex 520-Series power module.	B	25-PMFC-FB
		C	25-PMFC-FC
		D	25-PMFC-FD
		E	25-PMFC-FE
PowerFlex 520-Series Power Terminal Guard	Replacement finger guard for power terminals.	A	25-PTG1-FA
		B	25-PTG1-FB
		C	25-PTG1-FC
		D	25-PTG1-FD
		E	25-PTG1-FE
PowerFlex 527 Removable Terminal Blocks Kit	Replacement terminal blocks for control wiring.	A...E	25C-RCTB
PowerFlex 527 Control Module Internal Fan Kit	Replacement internal fan for the control module.	A...E	25C-FAN2-INT
PowerFlex 520-Series Heatsink Fan Kit	Replacement fan for drive power module.	A	25-FAN1-FA
		B	25-FAN1-FB
		C	25-FAN1-FC
		D	25-FAN1-FD
		E	25-FAN1-FE

Bulletin 1321-3R Series Line Reactors

Output Ratings ⁽¹⁾				Input Line Reactor ⁽³⁾⁽⁴⁾		Output Line Reactor ⁽³⁾⁽⁴⁾	
Normal Duty		Heavy Duty		IP00 (Open Style)	IP11 (NEMA/UL Type 1)	IP00 (Open Style)	IP11 (NEMA/UL Type 1)
HP	kW	HP	kW	Catalog No.	Catalog No.	Catalog No.	Catalog No.
200...240V 50/60 Hz 1-Phase⁽²⁾							
0.25	0.2	0.25	0.2	1321-3R4-A	1321-3RA4-A	1321-3R2-D	1321-3RA2-D
0.5	0.4	0.5	0.4	1321-3R8-A	1321-3RA8-A	1321-3R2-D	1321-3RA2-D
1.0	0.75	1.0	0.75	1321-3R8-A	1321-3RA8-A	1321-3R4-A	1321-3RA4-A
2.0	1.5	2.0	1.5	1321-3R18-A	1321-3RA18-A	1321-3R8-A	1321-3RA8-A
3.0	2.2	3.0	2.2	1321-3R18-A	1321-3RA18-A	1321-3R12-A	1321-3RA12-A
200...240V 50/60 Hz 3-Phase							
0.25	0.2	0.25	0.2	1321-3R2-D	1321-3RA2-D	1321-3R2-D	1321-3RA2-D

Bulletin 1321-3R Series Line Reactors

Output Ratings ⁽¹⁾				Input Line Reactor ⁽³⁾⁽⁴⁾		Output Line Reactor ⁽³⁾⁽⁴⁾	
Normal Duty		Heavy Duty		IP00 (Open Style)	IP11 (NEMA/UL Type 1)	IP00 (Open Style)	IP11 (NEMA/UL Type 1)
HP	kW	HP	kW	Catalog No.	Catalog No.	Catalog No.	Catalog No.
0.5	0.4	0.5	0.4	1321-3R2-D	1321-3RA2-D	1321-3R2-D	1321-3RA2-D
1.0	0.75	1.0	0.75	1321-3R4-A	1321-3RA4-A	1321-3R4-A	1321-3RA4-A
2.0	1.5	2.0	1.5	1321-3R8-A	1321-3RA8-A	1321-3R8-A	1321-3RA8-A
3.0	2.2	3.0	2.2	1321-3R12-A	1321-3RA12-A	1321-3R12-A	1321-3RA12-A
5.0	4.0	5.0	4.0	1321-3R18-A	1321-3RA18-A	1321-3R18-A	1321-3RA18-A
7.5	5.5	7.5	5.5	1321-3R25-A	1321-3RA25-A	1321-3R25-A	1321-3RA25-A
10.0	7.5	10.0	7.5	1321-3R35-A	1321-3RA35-A	1321-3R35-A	1321-3RA35-A
15.0	11.0	10.0	7.5	1321-3R45-A	1321-3RA45-A	1321-3R45-A	1321-3RA45-A
20.0	15.0	15.0	11.0	1321-3R55-A (ND) 1321-3R45-A (HD)	1321-3RA55-A (ND) 1321-3RA45-A (HD)	1321-3R55-A (ND) 1321-3R45-A (HD)	1321-3RA55-A (ND) 1321-3RA45-A (HD)

380...480V 50/60 Hz 3-Phase

0.5	0.4	0.5	0.4	1321-3R2-B	1321-3RA2-B	1321-3R2-B	1321-3RA2-B
1.0	0.75	1.0	0.75	1321-3R4-C	1321-3RA4-C	1321-3R4-C	1321-3RA4-C
2.0	1.5	2.0	1.5	1321-3R4-B	1321-3RA4-B	1321-3R4-B	1321-3RA4-B
3.0	2.2	3.0	2.2	1321-3R8-C	1321-3RA8-C	1321-3R8-C	1321-3RA8-C
5.0	4.0	5.0	4.0	1321-3R12-B	1321-3RA12-B	1321-3R12-B	1321-3RA12-B
7.5	5.5	7.5	5.5	1321-3R12-B	1321-3RA12-B	1321-3R12-B	1321-3RA12-B
10.0	7.5	10.0	7.5	1321-3R18-B	1321-3RA18-B	1321-3R18-B	1321-3RA18-B
15.0	11.0	15.0	11.0	1321-3R25-B	1321-3RA25-B	1321-3R25-B	1321-3RA25-B
20.0	15.0	15.0	11.0	1321-3R35-B (ND) 1321-3R25-B (HD)	1321-3RA35-B (ND) 1321-3RA25-B (HD)	1321-3R35-B (ND) 1321-3R25-B (HD)	1321-3RA35-B (ND) 1321-3RA25-B (HD)
25.0	18.5	20.0	15.0	1321-3R35-B	1321-3RA35-B	1321-3R35-B	1321-3RA35-B
30.0	22.0	25.0	18.5	1321-3R45-B (ND) 1321-3R35-B (HD)	1321-3RA45-B (ND) 1321-3RA35-B (HD)	1321-3R45-B (ND) 1321-3R35-B (HD)	1321-3RA45-B (ND) 1321-3RA35-B (HD)

525...600V 50/60 Hz 3-Phase

0.5	0.4	0.5	0.4	1321-3R1-C	1321-3RA1-C	1321-3R1-C	1321-3RA1-C
1.0	0.75	1.0	0.75	1321-3R2-B	1321-3RA2-B	1321-3R2-B	1321-3RA2-B
2.0	1.5	2.0	1.5	1321-3R4-C	1321-3RA4-C	1321-3R4-C	1321-3RA4-C
3.0	2.2	3.0	2.2	1321-3R4-B	1321-3RA4-B	1321-3R4-B	1321-3RA4-B
5.0	4.0	5.0	4.0	1321-3R8-C	1321-3RA8-C	1321-3R8-C	1321-3RA8-C
7.5	5.5	7.5	5.5	1321-3R12-B	1321-3RA12-B	1321-3R12-B	1321-3RA12-B
10.0	7.5	10.0	7.5	1321-3R12-B	1321-3RA12-B	1321-3R12-B	1321-3RA12-B
15.0	11.0	15.0	11.0	1321-3R18-B	1321-3RA18-B	1321-3R18-B	1321-3RA18-B
20.0	15.0	15.0	11.0	1321-3R25-B (ND) 1321-3R18-B (HD)	1321-3RA25-B (ND) 1321-3RA18-B (HD)	1321-3R25-B (ND) 1321-3R18-B (HD)	1321-3RA25-B (ND) 1321-3RA18-B (HD)
25.0	18.5	20.0	15.0	1321-3R35-C (ND) 1321-3R25-C (HD)	1321-3RA35-C (ND) 1321-3RA25-C (HD)	1321-3R35-C (ND) 1321-3R25-C (HD)	1321-3RA35-C (ND) 1321-3RA25-C (HD)
30.0	22.0	25.0	18.5	1321-3R35-C (ND) 1321-3R25-B (HD)	1321-3RA35-C (ND) 1321-3RA25-B (HD)	1321-3R35-C (ND) 1321-3R25-B (HD)	1321-3RA35-C (ND) 1321-3RA25-B (HD)

- (1) Normal Duty and Heavy Duty ratings for 15 HP (11 kW) and below are identical except for 200...240V 3-Phase 15 HP (11 kW) drive.
- (2) Standard 3-phase reactors can be used for 1-phase applications by routing each of the two supply conductors through an outside coil and leaving the center open.
- (3) Catalog numbers listed are for 3% impedance at 60Hz. 5% impedance reactor types are also available. See publication [1321-TD001](#).
- (4) Input line reactors were sized based on the NEC fundamental motor amps. Output line reactors were sized based on the VFD rated output currents.

Product Dimensions

The PowerFlex 527 drive is available in five frame sizes. See the [PowerFlex 527 Drive Ratings on page 139](#) for information on power ratings.

PowerFlex 527 Drive Weight

Frame Size	Weight (kg/lb)
A	1.1 / 2.4
B	1.6 / 3.5
C	2.3 / 5.0
D	3.9 / 8.6
E	12.9 / 28.4

IP 20/Open Type – Frame A

Dimensions are in millimeters and (inches)

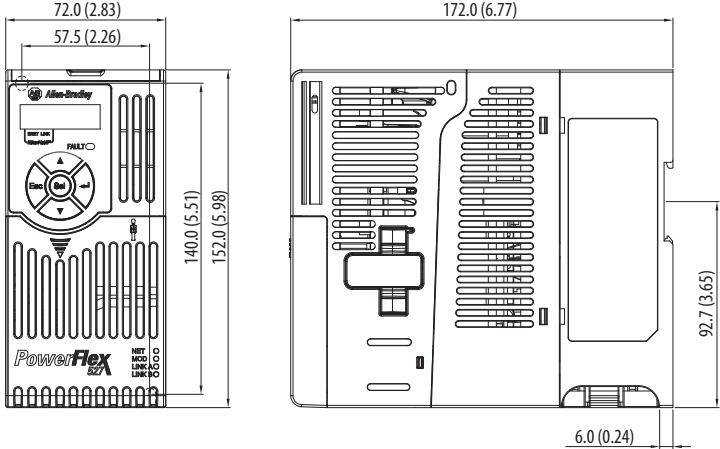

IP 20/Open Type – Frame B

Dimensions are in millimeters and (inches)

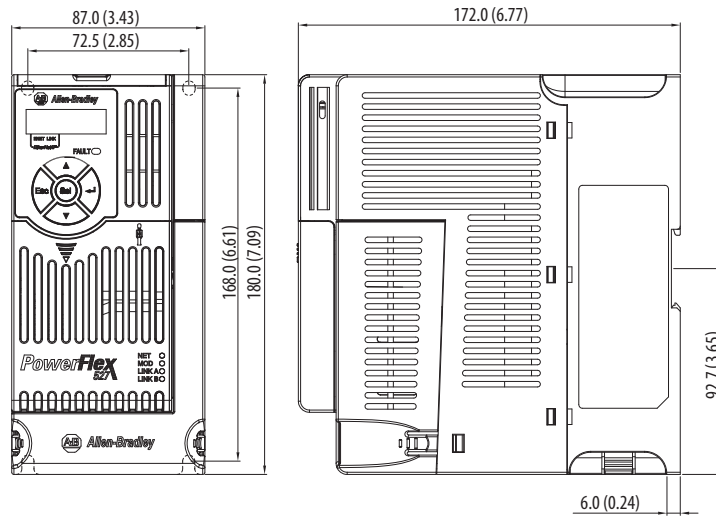

IP 20/Open Type – Frame C

Dimensions are in millimeters and (inches)

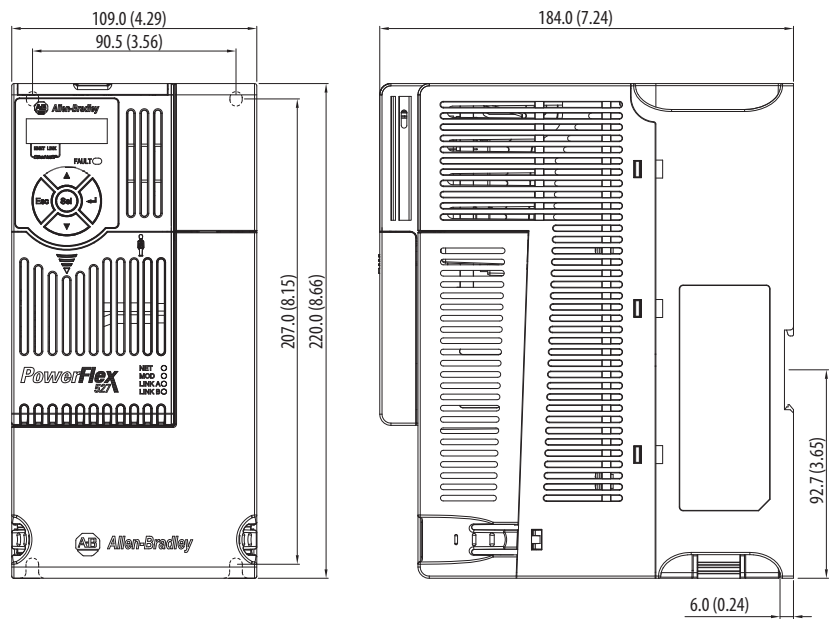

IP 20/Open Type – Frame D

Dimensions are in millimeters and (inches)

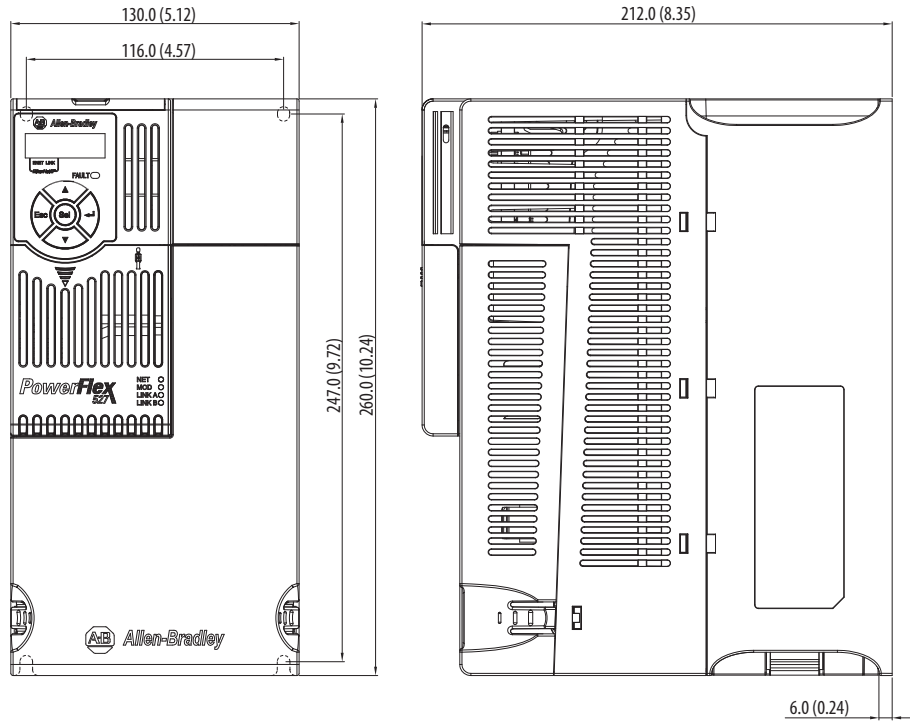

IP 20/Open Type – Frame E

Dimensions are in millimeters and (inches)

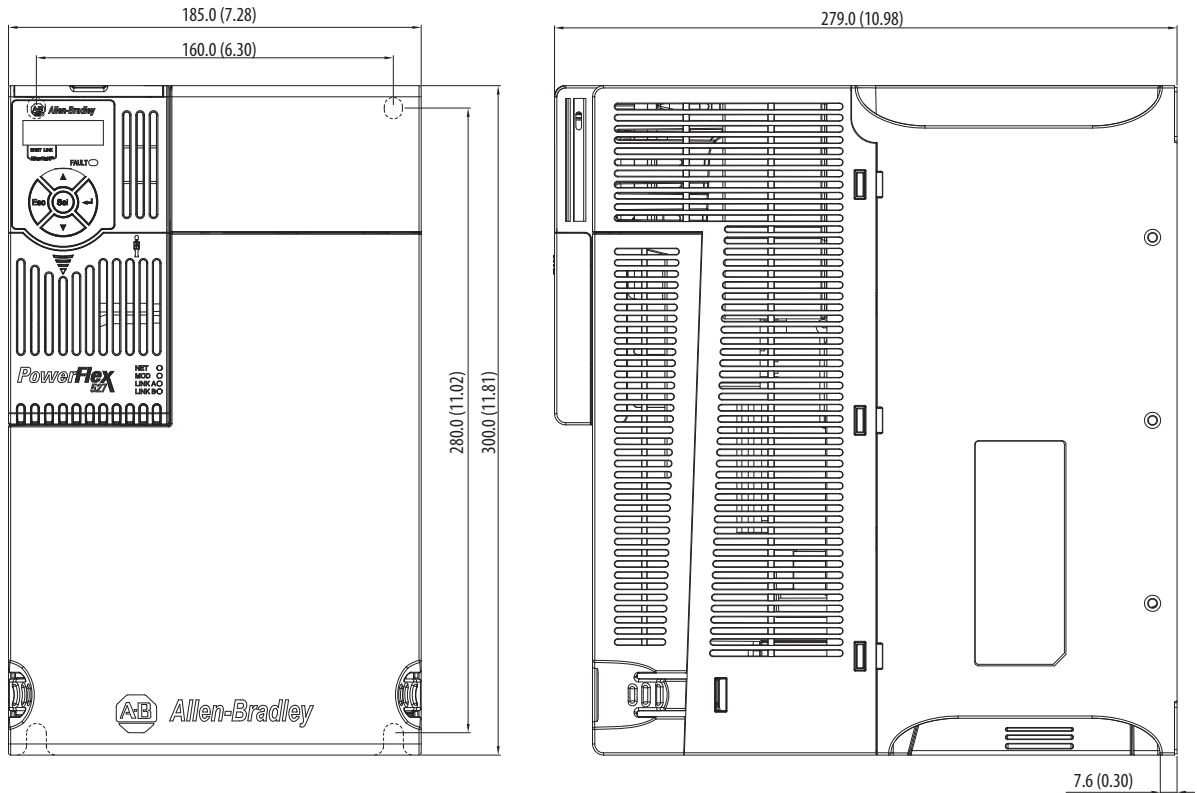

Control Module Fan Kit

25-FAN1-70C

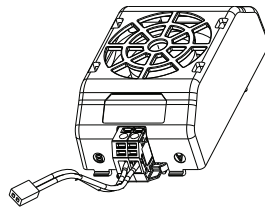

25-FAN2-70C

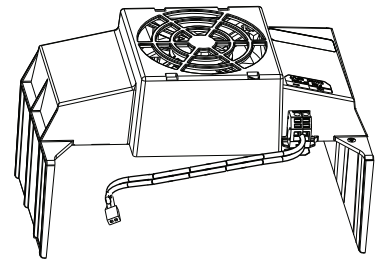

Specifications	25-FAN1-70C	25-FAN2-70C
Rated Voltage	24V DC	
Operation Voltage	14...27.6V DC	
Input Current	0.1 A	0.15 A
Speed (Reference)	7000 rpm	4500 ± 10% rpm
Maximum Air Flow (At zero static pressure)	0.575 m ³ /min	1.574 m ³ /min
Maximum Air Pressure (At zero air flow)	7.70 mmH ₂ O	9.598 mmH ₂ O
Acoustical Noise	40.5 dB-A	46.0 dB-A
Insulation Type	UL Class A	
Frame Size	Frame A...D	Frame E
Wire Size	0.32 mm ² (22 AWG)	
Torque	0.29...0.39 Nm (2.6...3.47 lb-in.)	

IP 20/Open Type with Control Module Fan Kit – Frame A...C

Dimensions are in millimeters and (inches)

Frame A

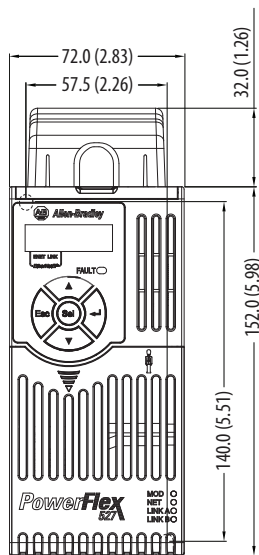

Frame B

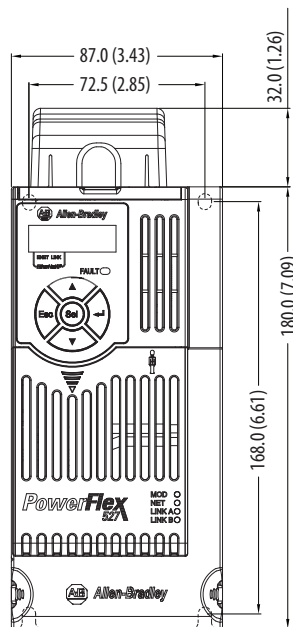

Frame C

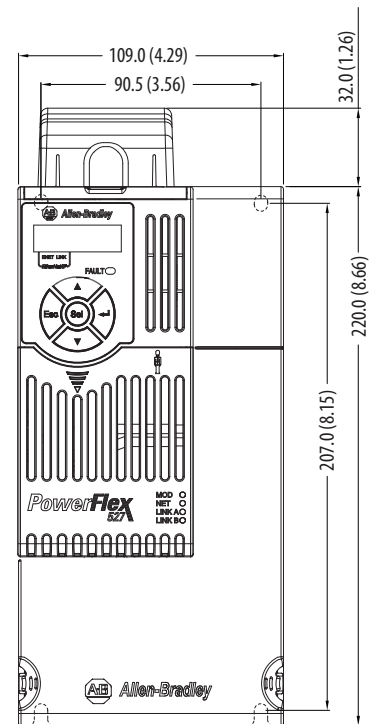

IMPORTANT

An external 24V DC power source is required when using the Control Module Fan Kit with drive frames A, B, and C.

IP 20/Open Type with Control Module Fan Kit – Frame D...E

Dimensions are in millimeters and (inches)

Frame D

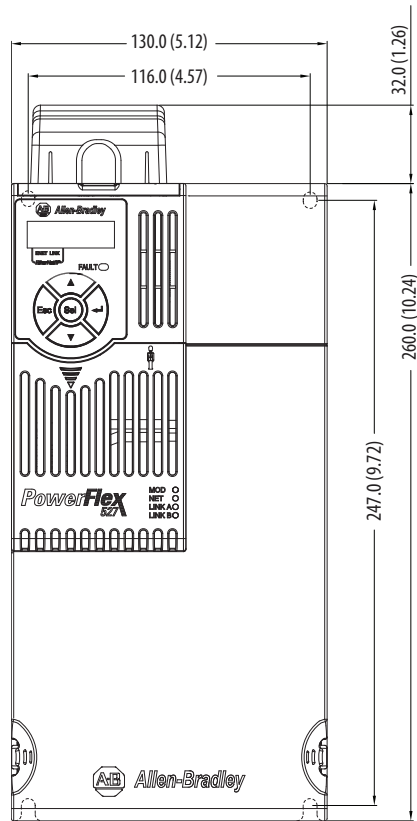

Frame E

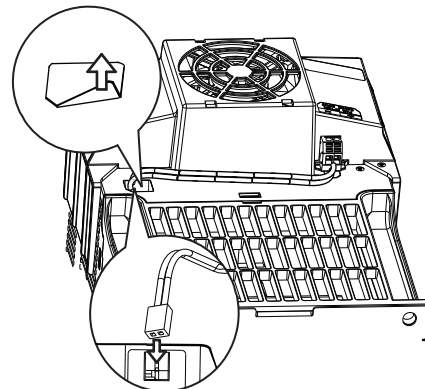
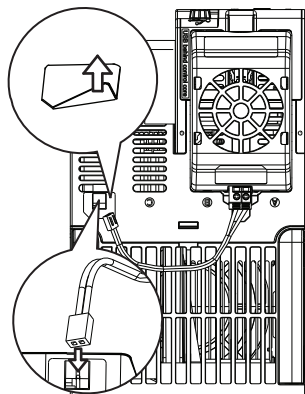
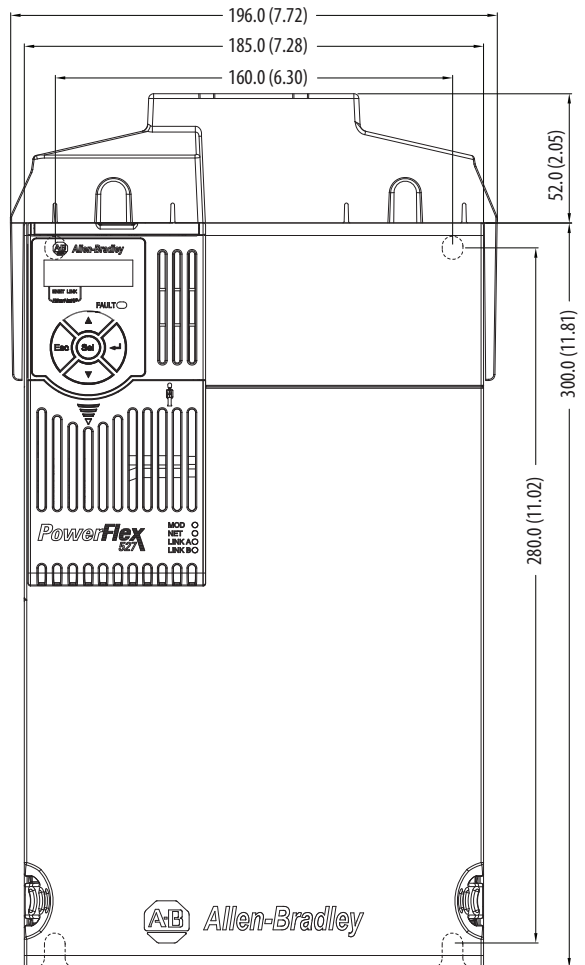

IMPORTANT Remove the label to access the built-in 24V supply on drive frames D and E for use with the Control Module Fan Kit.

IP 30/NEMA 1/UL Type 1 – Frame A

Dimensions are in millimeters and (inches)

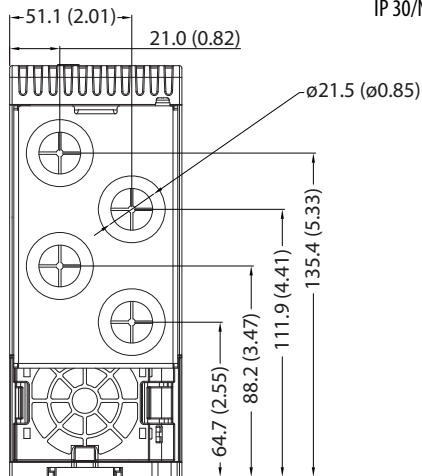
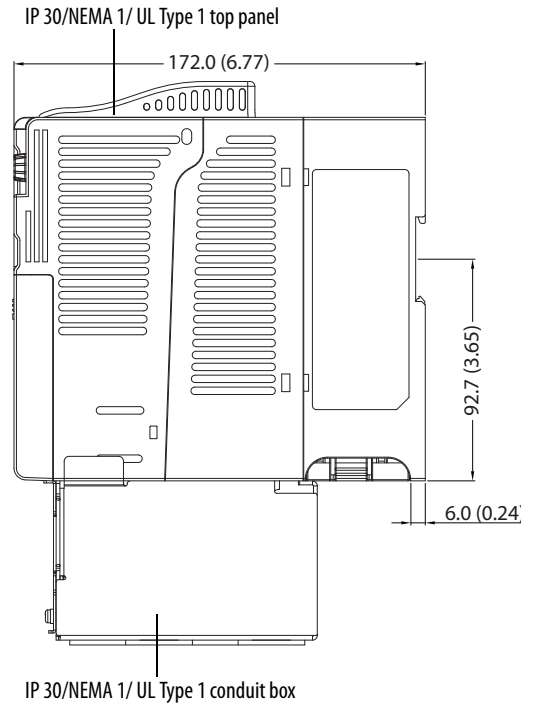
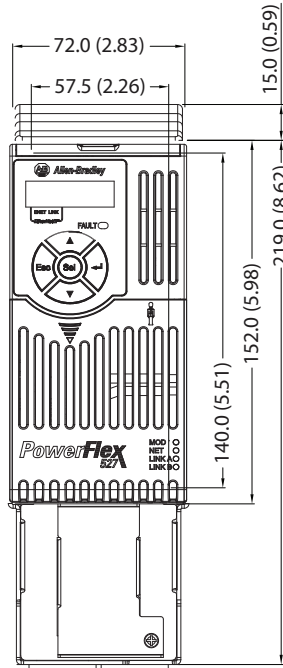

IP 30/NEMA 1/UL Type 1 – Frame B

Dimensions are in millimeters and (inches)

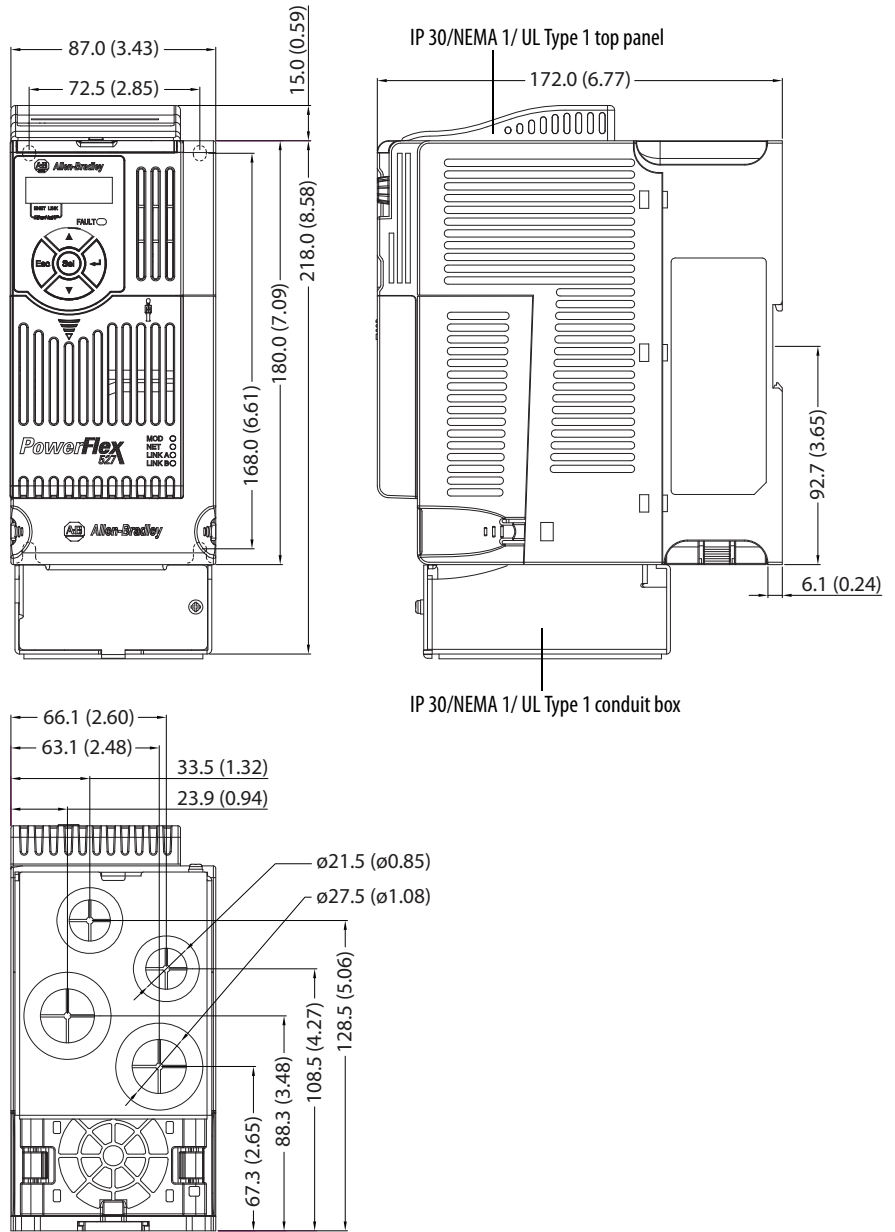

IP 30/NEMA 1/UL Type 1 – Frame C

Dimensions are in millimeters and (inches)

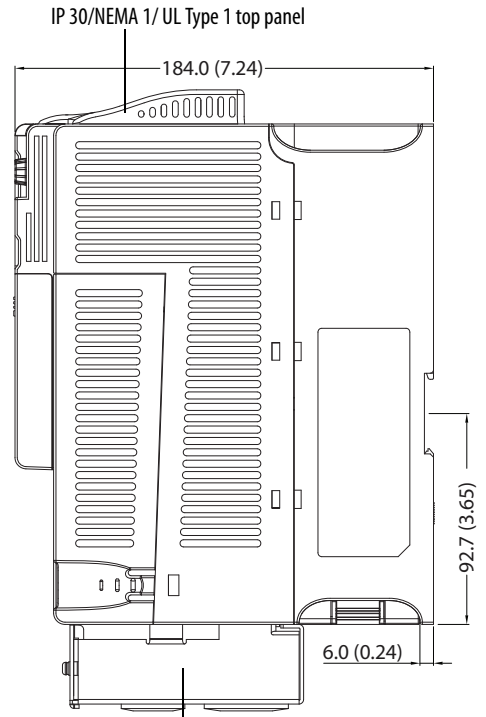
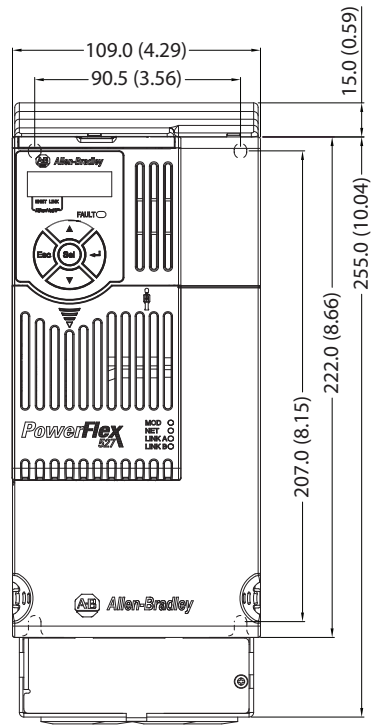

IP 30/NEMA 1/UL Type 1 conduit box

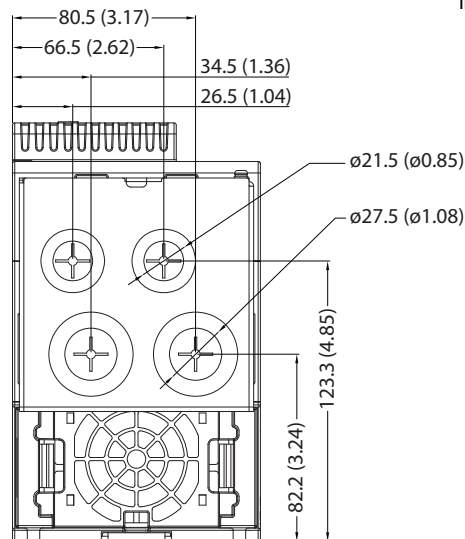

IP 30/NEMA 1/UL Type 1 – Frame D

Dimensions are in millimeters and (inches)

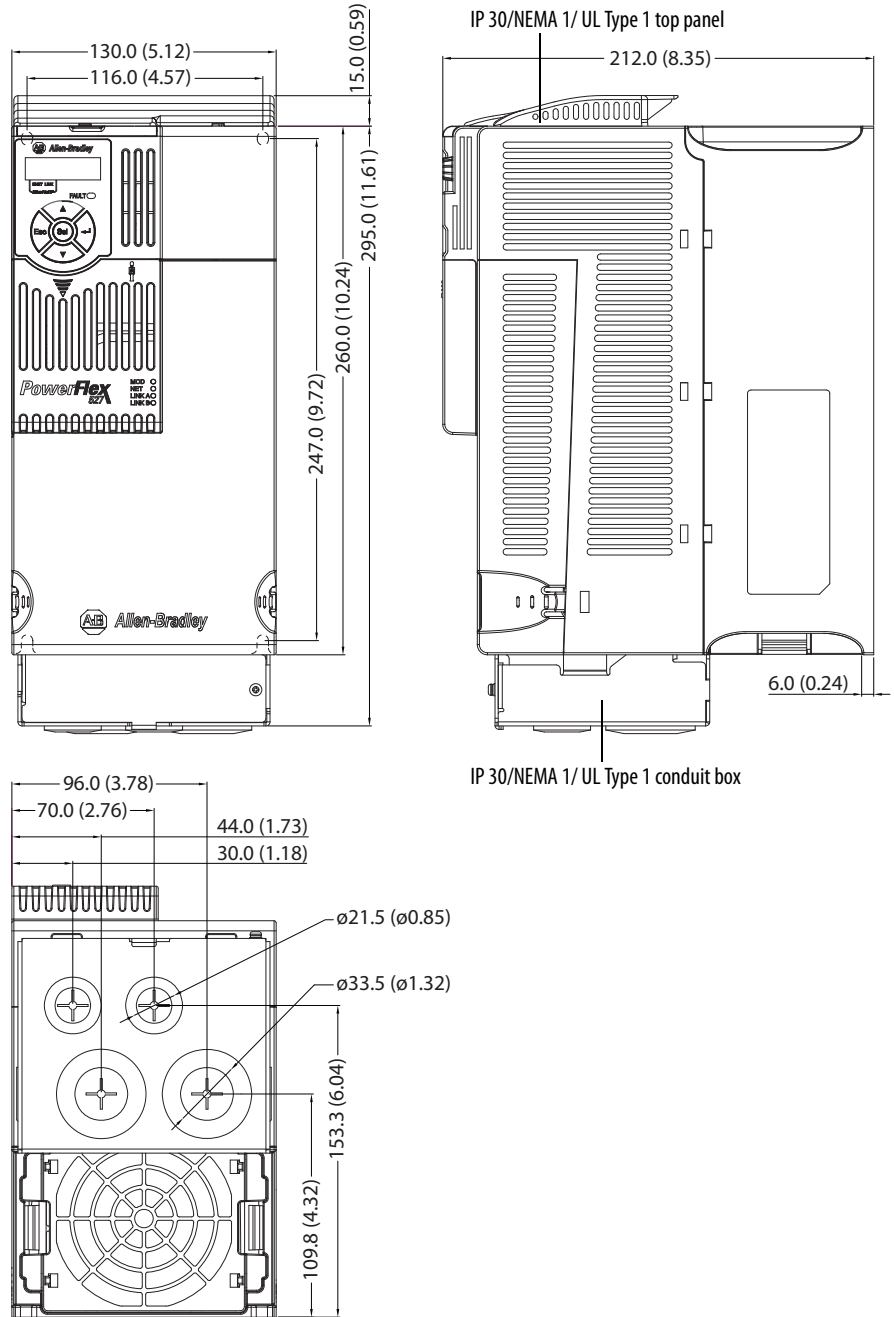

IP 30/NEMA 1/UL Type 1 – Frame E

Dimensions are in millimeters and (inches)

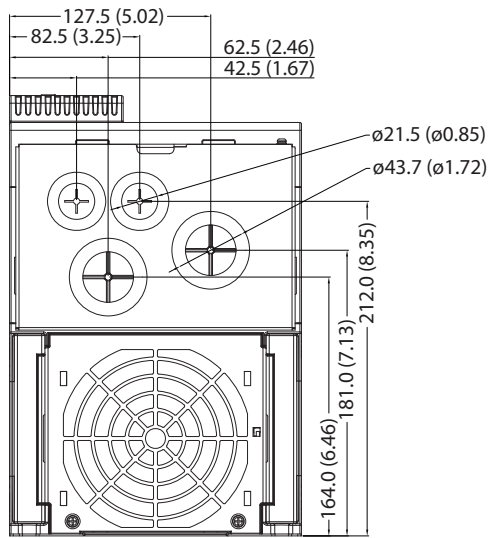
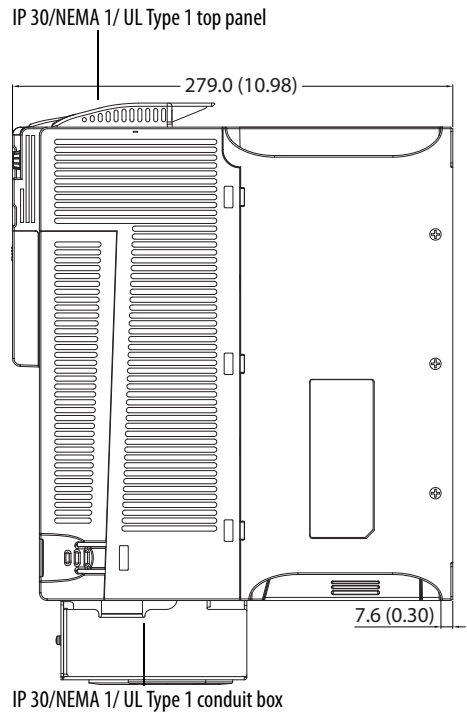
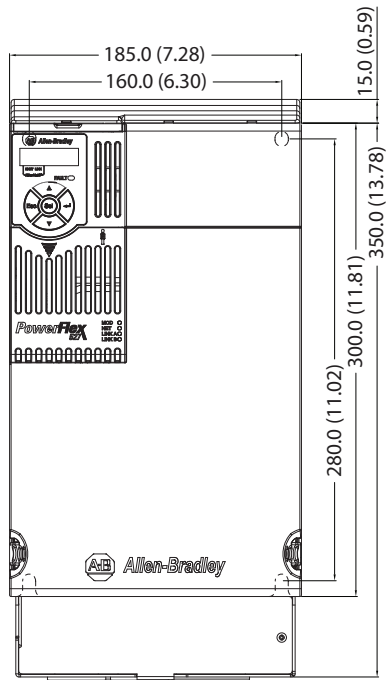

EMC Line Filter – Frame A

Dimensions are in millimeters and (inches)

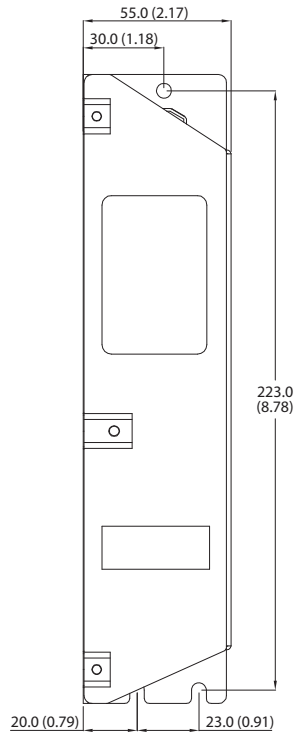

Filter can be mounted onto the back of the drive.

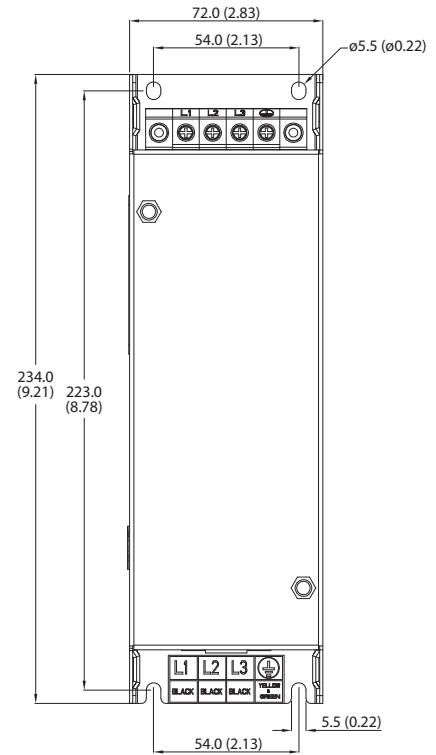

EMC Line Filter – Frame B

Dimensions are in millimeters and (inches)

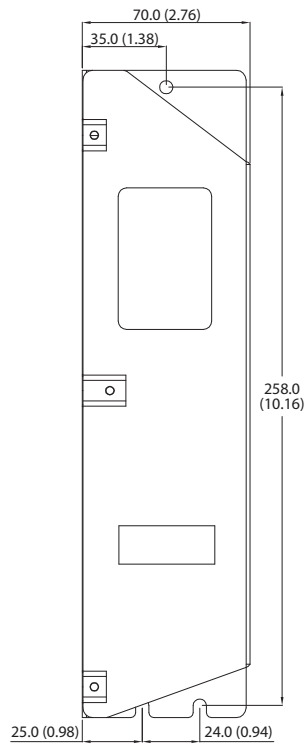

Filter can be mounted onto the back of the drive.

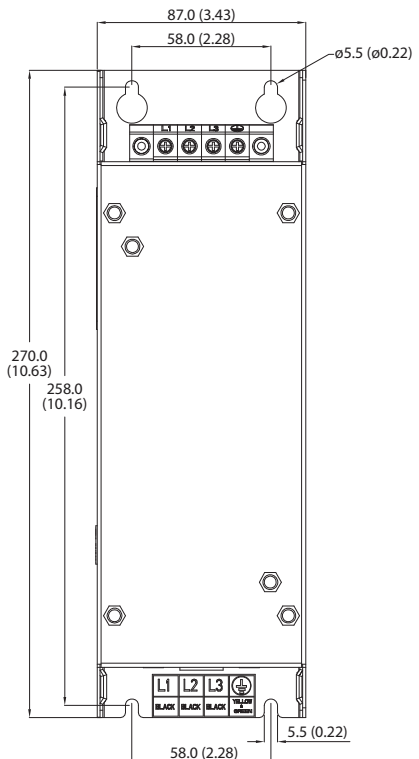

EMC Line Filter – Frame C

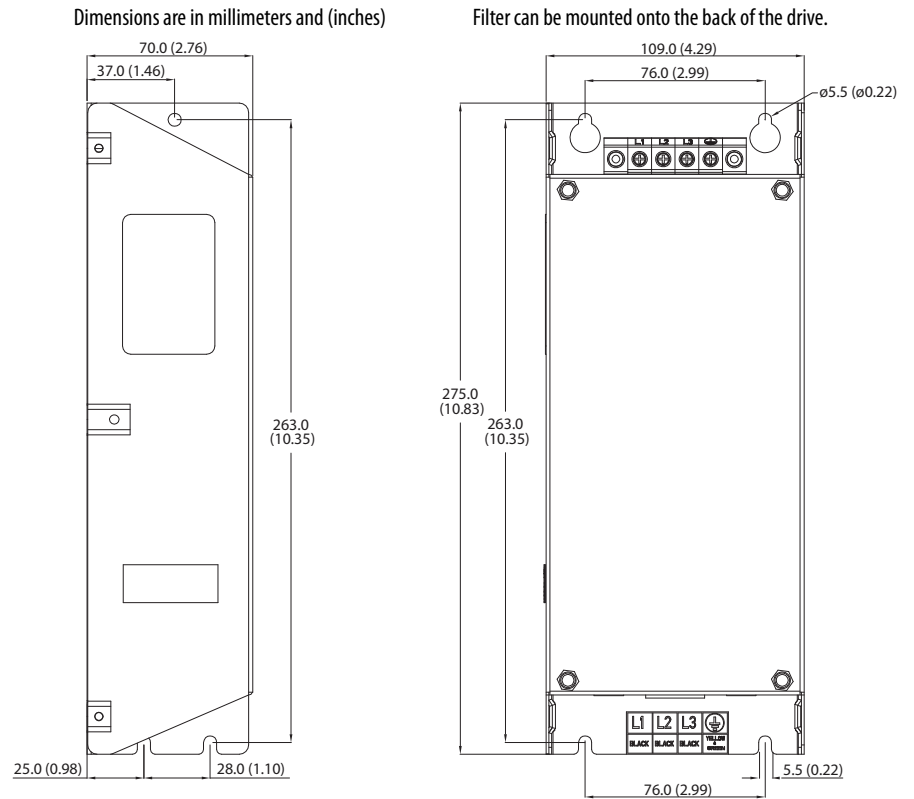

EMC Line Filter – Frame D

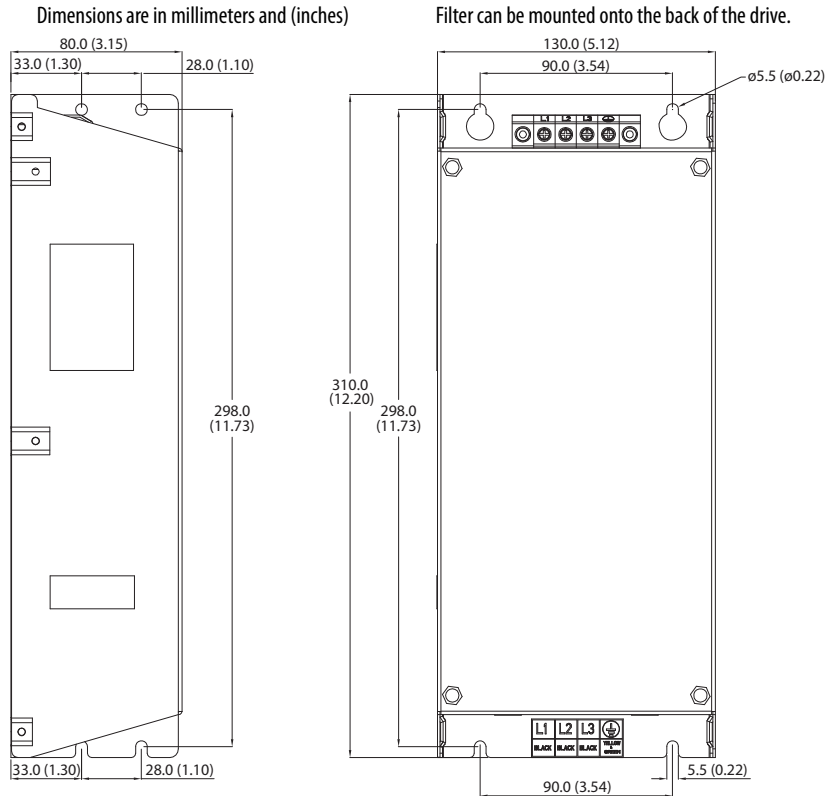

EMC Line Filter – Frame E

Dimensions are in millimeters and (inches)

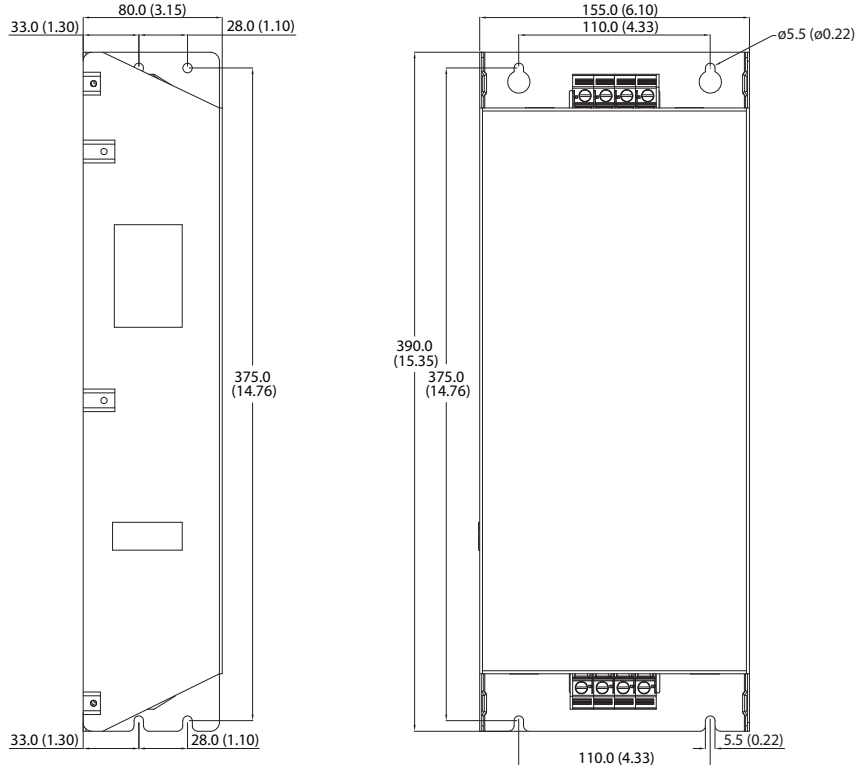
**Replacing the PowerFlex 527 Control Module Internal Fan**

To replace the internal fan, you need to separate the control module from the power module. Do not perform this operation while the drive is running. See the PowerFlex 527 Control Module Internal Fan Kit Installation Instructions, publication [520-IN014](#) for detailed instructions.



ATTENTION: Temperature inside the control module may exceed 80 °C (176 °F) when the internal fan is not working. Wait for the control module to cool down before replacing the internal fan.

ATTENTION: Take caution when replacing the internal fan as static damage may occur to sensitive components inside the drive.

Notes:

Out-of-Box Configuration

This section describes the recommended settings for configuring your PowerFlex 527 drive to obtain the best performance from the drive. You should apply these out-of-box settings first before configuring for your application.

Recommended Out-of-Box Settings

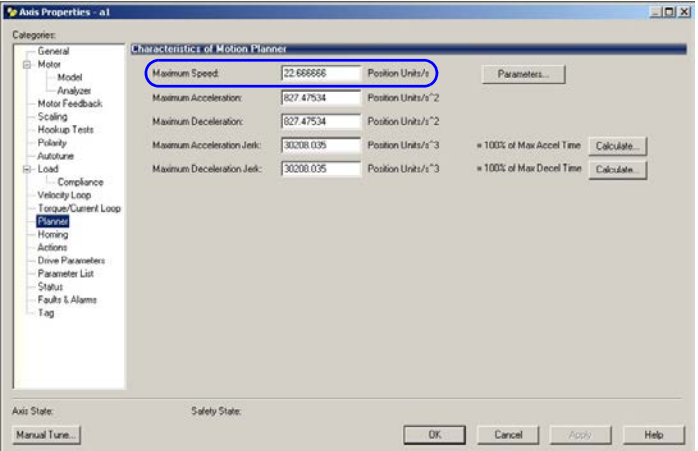
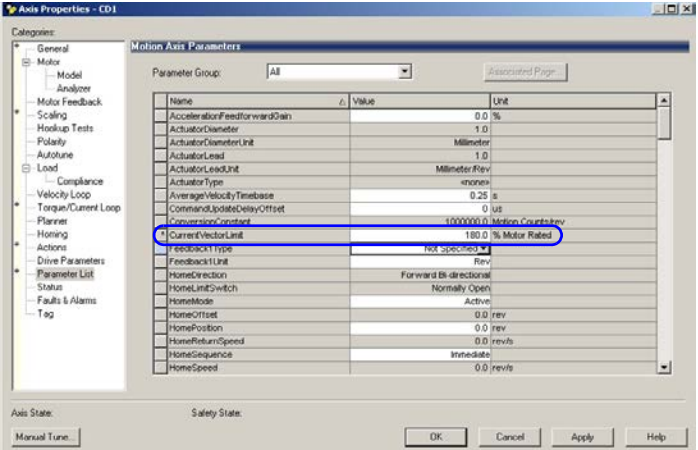
Setting in Logix Designer	Example	Recommended Configuration
Ramp Velocity Limits		120% of Motor Rated Speed for induction motors
Current Vector Limit		180% of Motor Rated Current

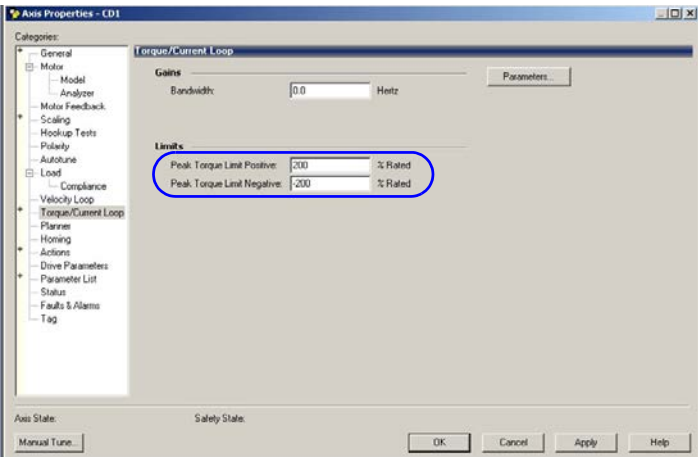
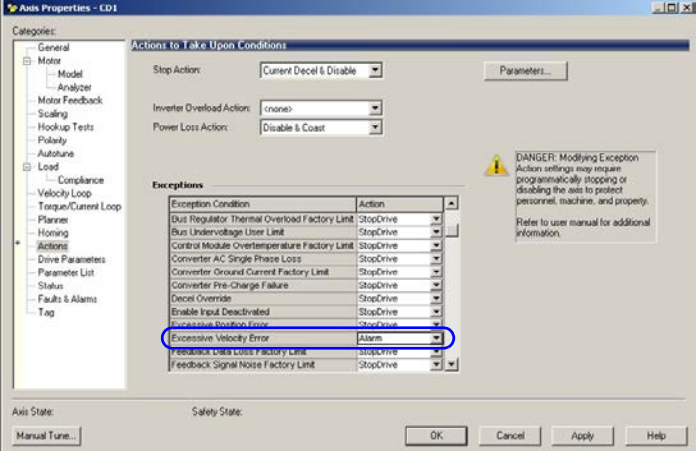
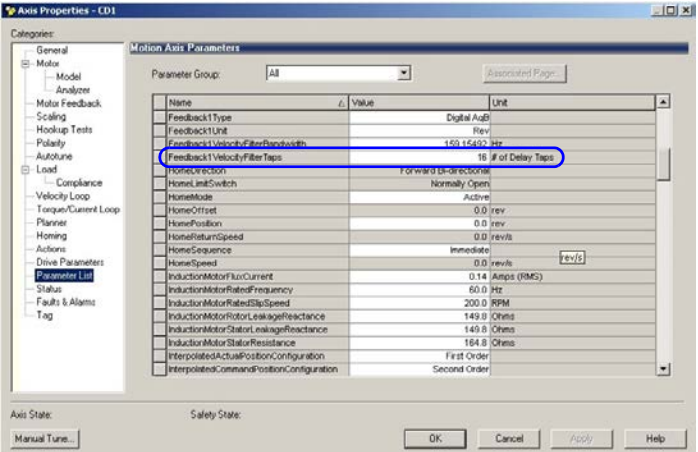
Setting in Logix Designer	Example	Recommended Configuration
Torque Limits		200% of Motor Rated Torque
Velocity Error Tolerance		Change action to alarm
Feedback Tap		16

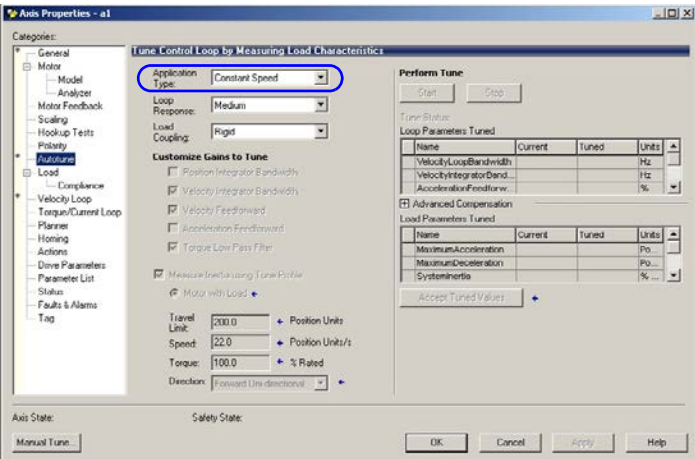
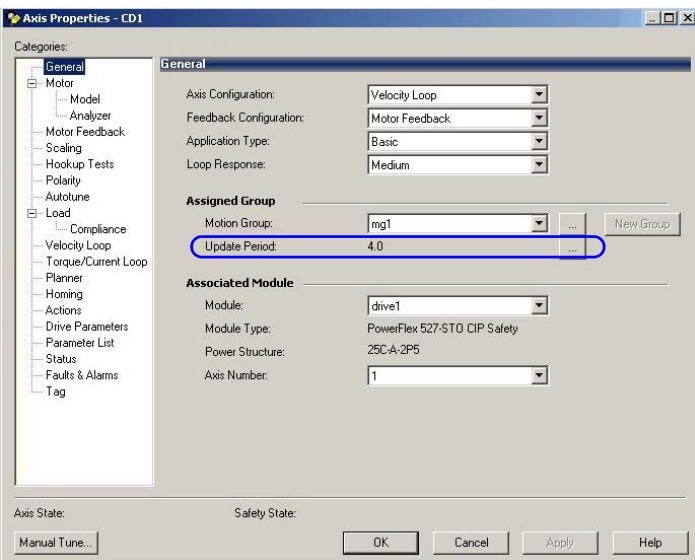
Setting in Logix Designer	Example	Recommended Configuration
<p>Application Type setting in Velocity Loop</p>		<p>Constant Speed</p>
<p>Motion Group Base Update Rate</p>		<p>4 ms</p>

Setting the ACO/AVO Attribute

The attribute ACO/AVO (Analog Current Output/Analog Voltage Output) can be used to set the analog output of the PowerFlex 527 drive to either current (mA) or voltage (V).

Ensure that the Analog Out jumper (J2) is also set to the same value. See [Analog Output on page 33](#) for instructions.

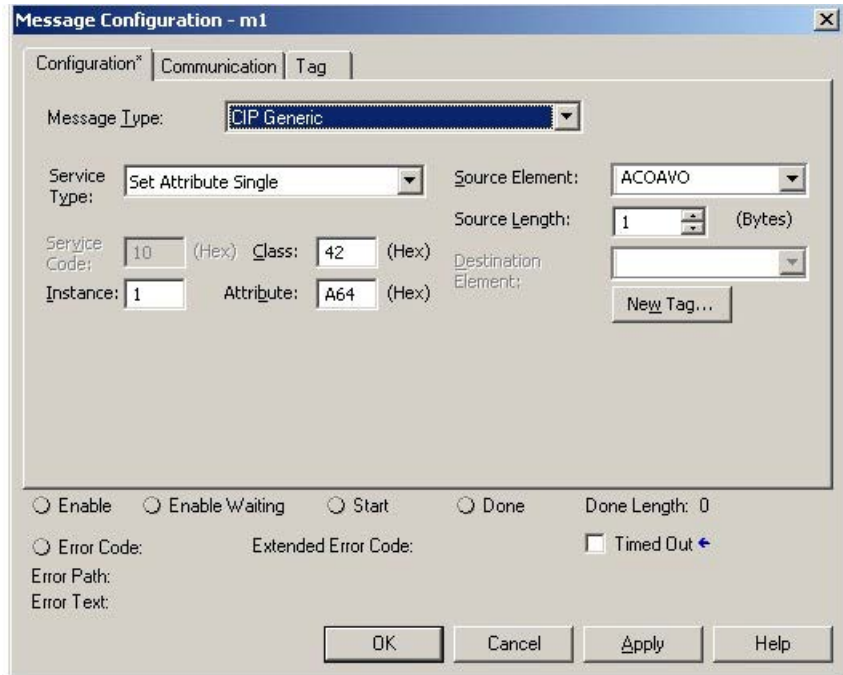

ACO/AVO: MSG

Parameter	Value	Description
Service Code	0x10	Get Attribute Single
Class	0x42	Analog Output
Instance	1	–
Attribute	0xA64	Voltage/Current Mode
Data Type	SINT	Unsigned Short Integer

ACO/AVO: Values

Value	Definition
0	Voltage (V)
1	Current (mA)

Encoder Option Card Usage

Installing the Encoder Option Card

To install the encoder option card:

1. Separate the power module and control module. See [Separating the Power and Control Module on page 23](#) for instructions.
2. Place the encoder option card on the back of the control module. Ensure that the tabs on the encoder option card are aligned with the slots on the control module.

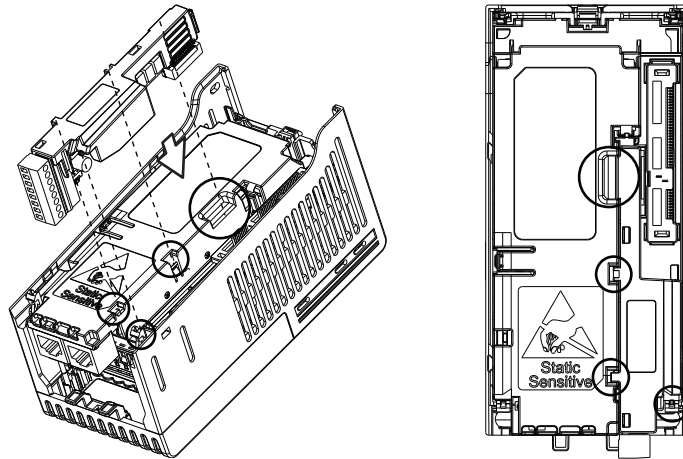

3. Press down firmly on the encoder option card until it snaps together with the control module.

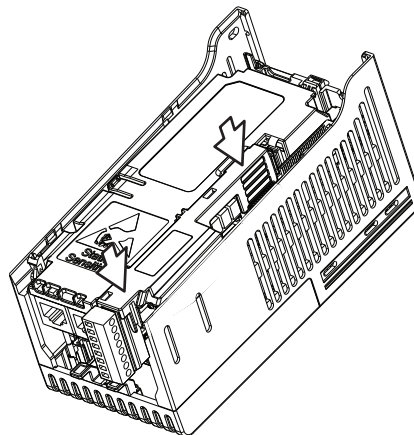

Removing the Encoder Option Card

To remove the encoder option card:

1. Hold the top of the encoder option card firmly as shown below and pull out to remove.

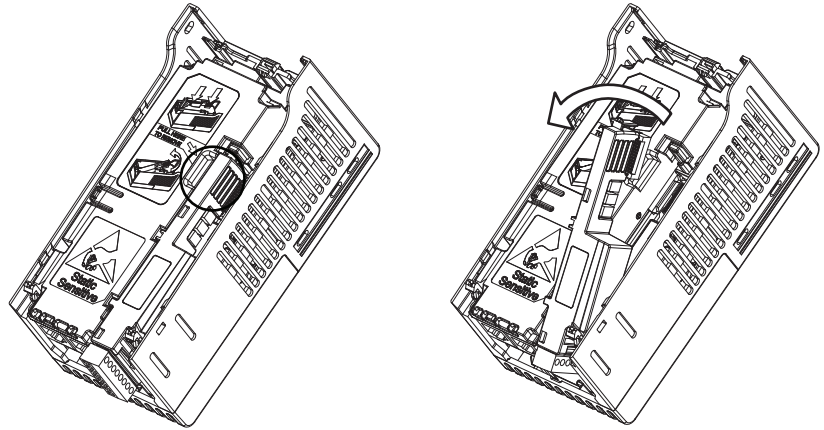

IMPORTANT Do not remove the encoder option card from the bottom as it may damage the card and the locking mechanism on the control module.

Encoder Option Card Usage

PowerFlex 527 drives support an optional encoder card. The encoder supports up to 250 kHz dual channel at 5, 12 or 24V and requires the optional encoder board to be installed.

When the axis configuration is set to Position or Velocity loop, the Feedback Configuration is enabled.

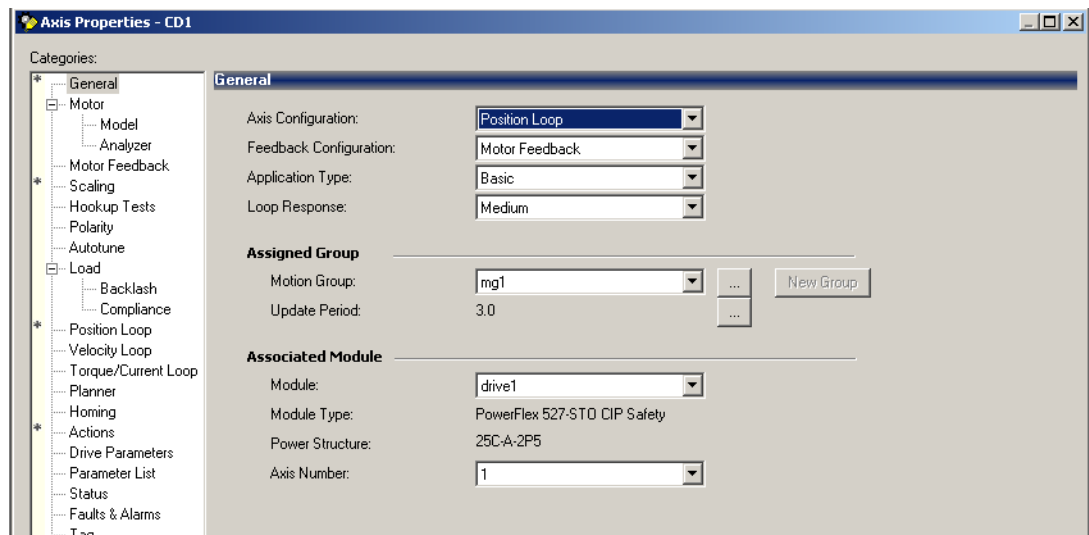

In the Motor Feedback configuration, enter the resolution of the encoder used.

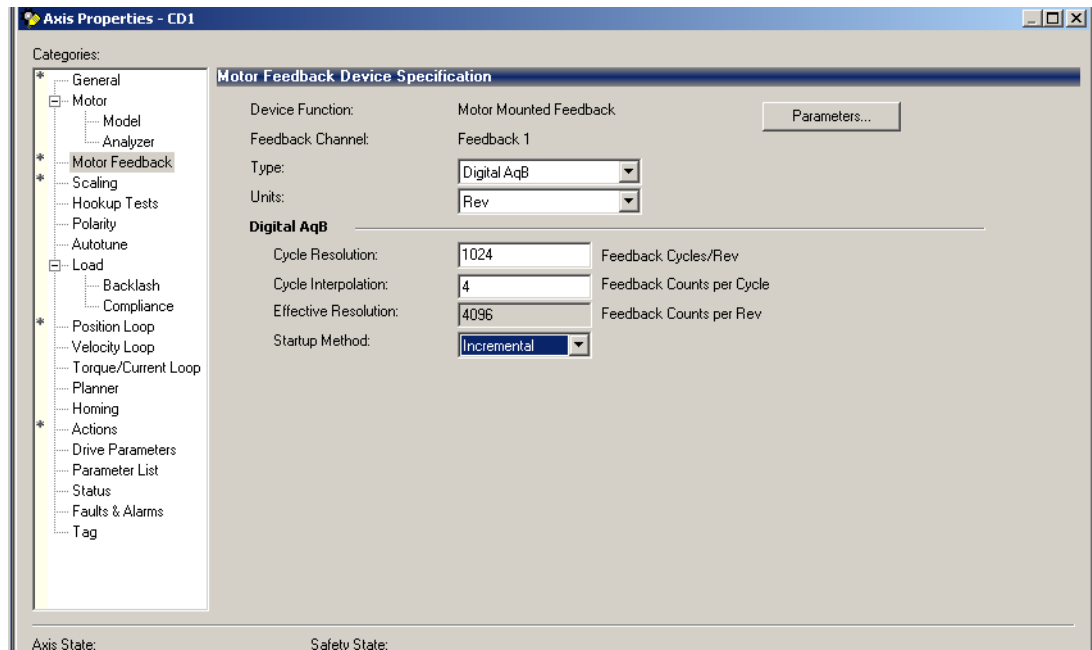

Encoder Interface

The incremental encoder option card can source 5 or 12 volt power and accept 5, 12 or 24 volt single ended or differential inputs. See [Appendix B](#) for ordering information.

No.	Signal	Description
+V	+V 5...12V Power ⁽¹⁾⁽²⁾	Internal power source 250 mA (isolated).
Cm	Power Return	
Z-	Marker Z (NOT)	Marker pulse
Z	Marker Z	
B-	Encoder B (NOT)	Quadrature B input.
B	Encoder B	
A-	Encoder A (NOT)	Single channel, quadrature A input.
A	Encoder A	
	1 Output	DIP switch selects 12 or 5 volt power supplied at terminals "+V" and "Cm" for the encoder.

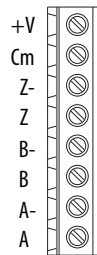

- (1) When using 12V Encoder power, 24V I/O power, maximum output current at I/O Terminal 11 is 50 mA.
 (2) If Encoder requires 24V power, it must be supplied by an external power source.

IMPORTANT

A quadrature encoder provides rotor speed and direction. Therefore, the encoder must be wired such that the forward direction matches the motor forward direction. If the drive is reading encoder speed but the position regulator or other encoder function is not working properly, remove power to the drive and swap the A and A (NOT) encoder channels or swap any two motor leads.

Encoder Wiring Examples

I/O	Connection Example	I/O	Connection Example
Encoder Power – Internal Drive Power Internal (drive) 12V DC, 250mA		Encoder Power – External Power Source	
Encoder Signal – Single-Ended, Dual Channel		Encoder Signal – Differential, Dual Channel	

Wiring Notes

The encoder option card can supply 5V or 12V power (250 mA maximum) for an encoder. Be sure the DIP switch is set properly for the encoder. In general, 12V will provide higher noise immunity.

The encoder can handle 5V, 12V, or 24V inputs. The inputs will automatically adjust to the voltage applied and no additional drive adjustment is necessary.

IMPORTANT A quadrature encoder provides rotor speed and direction. Therefore, the encoder must be wired such that the forward direction matches the motor forward direction. If the drive is reading encoder speed but the position regulator or other encoder function is not working properly, remove power to the drive and swap the A and A (NOT) encoder channels or swap any two motor leads.

A

accessing
 control terminals, **26**
 power terminals, **26**
 auxiliary contact
 drive, **29**

B

basic operation
 drive, **42**

C

circuit breakers
 inputs, **18**
 ratings, **18**
 control terminals
 accessing, **26**

D

derating
 temperature, **13**
 dimensions
 mounting, **12, 147**
 disconnect
 output, **29**
 drive
 auxiliary contact, **29**
 basic operation, **42**
 mount, **11**
 programming, **47**
 drive damage
 preventing, **15**
 ungrounded distribution systems, **15**

E

encoder
 wiring, **168**
 environment
 storage, **14**

F

fault monitoring
 ground, **17**
 fuses
 rating, **18**

G

ground
 fault monitoring, **17**
 motor, **17**
 RFI filter, **17**
 safety, **17**
 shielding, **17**

I

inputs
 circuit breakers, **18**
 power, **16**

M

motor
 ground, **17**
 start, **29**
 stop, **29**
 mount
 drive, **11**
 mounting
 dimensions, **12, 147**

N

noise immunity
 wiring, **31**

O

output
 disconnect, **29**

P

power
 inputs, **16**
 power and control module
 separating, **23**
 power terminals
 accessing, **26**
 preventing
 drive damage, **15**
 programming
 drive, **47**
 tools, **47**

R

rating
 fuses, **18**
 ratings
 circuit breakers, **18**
 recommended
 wiring, **30, 31**
 reflected
 wave protection, **29**
 RFI filter
 ground, **17**

S

safety
 ground, **17**
 separating
 power and control module, **23**

shielded
wiring, **28**
shielding
ground, **17**
start
motor, **29**
stop
motor, **29**
storage
environment, **14**

T

temperature
derating, **13**
wiring, **28**
tools
programming, **47**

U

unshielded
wiring, **28**

V

voltage reflections
wiring, **29**

W

wave protection
reflected, **29**
wiring
encoder, **168**
noise immunity, **31**
recommended, **30, 31**
shielded, **28**
temperature, **28**
unshielded, **28**
voltage reflections, **29**

Rockwell Automation Support

Rockwell Automation provides technical information on the Web to assist you in using its products.

At <http://www.rockwellautomation.com/support/>, you can find technical manuals, a knowledge base of FAQs, technical and application notes, sample code and links to software service packs, and a MySupport feature that you can customize to make the best use of these tools.

For an additional level of technical phone support for installation, configuration, and troubleshooting, we offer TechConnect support programs. For more information, contact your local distributor or Rockwell Automation representative, or visit <http://www.rockwellautomation.com/support/>.

Installation Assistance

If you experience a problem within the first 24 hours of installation, review the information that is contained in this manual. You can contact Customer Support for initial help in getting your product up and running.

United States or Canada	1.440.646.3434
Outside United States or Canada	Use the Worldwide Locator at http://www.rockwellautomation.com/support/americas/phone_en.html , or contact your local Rockwell Automation representative.

New Product Satisfaction Return

Rockwell Automation tests all of its products to ensure that they are fully operational when shipped from the manufacturing facility. However, if your product is not functioning and needs to be returned, follow these procedures.

United States	Contact your distributor. You must provide a Customer Support case number (call the phone number above to obtain one) to your distributor to complete the return process.
Outside United States	Please contact your local Rockwell Automation representative for the return procedure.

Documentation Feedback

Your comments will help us serve your documentation needs better. If you have any suggestions on how to improve this document, complete this form, publication [RA-DU002](#), available at <http://www.rockwellautomation.com/literature/>.

www.rockwellautomation.com

Power, Control and Information Solutions Headquarters

Americas: Rockwell Automation, 1201 South Second Street, Milwaukee, WI 53204-2496 USA, Tel: (1) 414.382.2000, Fax: (1) 414.382.4444

Europe/Middle East/Africa: Rockwell Automation NV, Pegasus Park, De Kleetlaan 12a, 1831 Diegem, Belgium, Tel: (32) 2 663 0600, Fax: (32) 2 663 0640

Asia Pacific: Rockwell Automation, Level 14, Core F, Cyberport 3, 100 Cyberport Road, Hong Kong, Tel: (852) 2887 4788, Fax: (852) 2508 1846